

User Manual

FaceKoisk-H13

Date: June 2020

Doc Version: 2.0

English

Thank you for choosing our product. Please read the instructions carefully before operation. Follow these instructions to ensure that the product is functioning properly. The images shown in this manual are for illustrative purposes only.



For further details, please visit our Company's website

<https://www.zkteco.in/>

Copyright © 2020 ZKTECO CO., LTD. All rights reserved.

Without the prior written consent of ZKTeco, no portion of this manual can be copied or forwarded in any way or form. All parts of this manual belong to ZKTeco and its subsidiaries (hereinafter the "Company" or "ZKTeco").

Trademark

ZKTeco is a registered trademark of ZKTeco. Other trademarks involved in this manual are owned by their respective owners.

Disclaimer

This manual contains information on the operation and maintenance of the ZKTeco equipment. The copyright in all the documents, drawings, etc. in relation to the ZKTeco supplied equipment vests in and is the property of ZKTeco. The contents hereof should not be used or shared by the receiver with any third party without express written permission of ZKTeco.

The contents of this manual must be read as a whole before starting the operation and maintenance of the supplied equipment. If any of the content(s) of the manual seems unclear or incomplete, please contact ZKTeco before starting the operation and maintenance of the said equipment.

It is an essential pre-requisite for the satisfactory operation and maintenance that the operating and maintenance personnel are fully familiar with the design and that the said personnel have received thorough training in operating and maintaining the machine/unit/equipment. It is further essential for the safe operation of the machine/unit/equipment that personnel has read, understood and followed the safety instructions contained in the manual.

In case of any conflict between terms and conditions of this manual and the contract specifications, drawings, instruction sheets or any other contract-related documents, the contract conditions/documents shall prevail. The contract specific conditions/documents shall apply in priority.

ZKTeco offers no warranty, guarantee or representation regarding the completeness of any information contained in this manual or any of the amendments made thereto. ZKTeco does not extend the warranty of any kind, including, without limitation, any warranty of design, merchantability or fitness for a particular purpose.

ZKTeco does not assume responsibility for any errors or omissions in the information or documents which are referenced by or linked to this manual. The entire risk as to the results and performance obtained from using the information is assumed by the user.

ZKTeco in no event shall be liable to the user or any third party for any incidental, consequential, indirect, special, or exemplary damages, including, without limitation, loss of business, loss of profits, business interruption, loss of business information or any pecuniary loss, arising out of, in connection with, or relating to the use of the information contained in or referenced by this manual, even if ZKTeco has been advised of the possibility of such damages.

This manual and the information contained therein may include technical, other inaccuracies or typographical errors. ZKTeco periodically changes the information herein which will be incorporated into new additions/amendments to the manual. ZKTeco reserves the right to add, delete, amend or modify the information contained in the manual from time to time in the form of circulars, letters, notes, etc. for better

operation and safety of the machine/unit/equipment. The said additions or amendments are meant for improvement /better operations of the machine/unit/equipment and such amendments shall not give any right to claim any compensation or damages under any circumstances.

ZKTeco shall in no way be responsible (i) in case the machine/unit/equipment malfunctions due to any non-compliance of the instructions contained in this manual (ii) in case of operation of the machine/unit/equipment beyond the rate limits (iii) in case of operation of the machine and equipment in conditions different from the prescribed conditions of the manual.

The product will be updated from time to time without prior notice. The latest operation procedures and relevant documents are available on

<https://www.zkteco.in/>

If there is any issue related to the product, please contact us.

ZKTeco India

Address ZKTeco Biometric India Pvt. Ltd. ,
Survey No 01/01, Outer Ring Road, Mahadevpura,
Bengaluru, Karnataka – 560048

Phone 080-68281342/48

For business related queries, please write to us at: sales@zkteco.in

To know more about our global branches, visit www.zkteco.in

About the Company

ZKTeco is one of the world's largest manufacturer of RFID and Biometric (Fingerprint, Facial, Finger-vein) readers. Product offerings include Access Control readers and panels, Near & Far-range Facial Recognition Cameras, Elevator/floor access controllers, Turnstiles, License Plate Recognition (LPR) gate controllers and Consumer products including battery-operated fingerprint and face-reader Door Locks. Our security solutions are multi-lingual and localized in over 18 different languages. At the ZKTeco state-of-the-art 700,000 square foot ISO9001-certified manufacturing facility, we control manufacturing, product design, component assembly, and logistics/shipping, all under one roof.

The founders of ZKTeco have been determined for independent research and development of biometric verification procedures and the productization of biometric verification SDK, which was initially widely applied in PC security and identity authentication fields. With the continuous enhancement of the development and plenty of market applications, the team has gradually constructed an identity authentication ecosystem and smart security ecosystem, which are based on biometric verification techniques. With years of experience in the industrialization of biometric verifications, ZKTeco was officially established in 2007 and now has been one of the globally leading enterprises in the biometric verification industry owning various patents and being selected as the National High-tech Enterprise for 6 consecutive years. Its products are protected by intellectual property rights.

About the Manual

This manual introduces the operations of FaceKiosk-H13 product.

All figures displayed are for illustration purposes only. Figures in this manual may not be exactly consistent with the actual products.

Document Conventions

Conventions used in this manual are listed below:

GUI Conventions

For Software	
Convention	Description
Bold font	Used to identify software interface names e.g. OK, Confirm, Cancel
>	Multi-level menus are separated by these brackets. For example, File > Create > Folder.
For Device	
Convention	Description
< >	Button or key names for devices. For example, press <OK>
[]	Window names, menu items, data table, and field names are inside square brackets. For example, pop up the [New User] window
/	Multi-level menus are separated by forwarding slashes. For example, [File/Create/Folder].

Symbols





Convention	Description
	This implies about the notice or pays attention to, in the manual
	The general information which helps in performing the operations faster
	The information which is significant
	Care taken to avoid danger or mistakes
	The statement or event that warns of something or that serves as a cautionary example.

Table of Contents

1 Overview	7
1.1 Specifications	7
1.2 Installation set-up	8
1.2.1 Safety Precautions	8
1.2.2 Installation Environment	8
1.2.3 Installation Procedure	8
1.3 Product Appearance	12
1.4 Product Interface	14
1.5 Device Connection	14
2 Home Screen and Main Menu	16
2.1 Main Menu	17
3 Employee Management	19
3.1 Add an employee	19
3.2 Delete an employee	25
4 Communication Settings	26
4.1 Wi-Fi Settings	26
4.2 Ethernet Settings	26
4.3 Server Settings	27
5 System Settings	28
5.1 Time and Date	28
5.2 Biometric Parameter	29
5.3 Attendance Parameters	31
5.3.1 Attendance Mode Setting	32
5.4 Detection Management	35
5.5 Menu Timeout	37
5.6 Full Capacity Circular Deletion	37
5.7 Stranger Recognition	38
5.8 Stranger Alarm	38
5.9 Save Blacklist Photos	39
5.10 Blacklist Alarm	39
5.11 Barcode Scanner	39
5.12 QR Code Setting	40
6 Data Management	42
6.1 Clear Data	42
6.2 Backup Data	43
6.3 Restore Data	44
7 USB Management	45
7.1 Uploading Data from the USB drive	45

7.2 Downloading Data to the USB drive.....	46
8 Record Search	47
8.1 Attendance Records and Photos.....	47
8.2 Stranger's Photo.....	48
8.3 Blacklist Photo.....	49
9 Print Management.....	50
9.1 Print Objects	50
9.2 Print Format	52
9.3 Print Options.....	53
10 System Information	55
11 Advertisement Setting.....	56
12 Personality Setting.....	58
13 Access Control Management.....	61
13.1 Access Control Parameters.....	61
13.2 Wiegand Output Setting.....	62
14 BioTime 8.0 Connection.....	63
14.1 Adding a Device.....	63
14.2 User Management.....	64
14.3 Attendance Management.....	65
15 ZKBiosecurity Connection.....	66
15.1 Adding a Device.....	66
15.2 User Management.....	66
15.2.1 Adding a User	66
15.2.2 Importing User Data and Photo	67
15.3 Adding Advertisement.....	68
15.3.1 Add Advertising Pictures and Videos.....	69
15.3.2 Advertisement Settings.....	69
15.4 Attendance Management.....	71
15.5 Scan Code Registration.....	71

1 Overview

FaceKiosk-H13 is a multi-purpose smart face recognition device with the android operating system. It provides the best solution for various enterprise requirements such as Time & Attendance, Access Control, Meeting Assistance, Self-service Kiosk, Advertisers in a user-friendly manner with interactive user experience. The installation is very simple and its compact structure makes it best-fit in any working environment.

1.1 Specifications

Product: FaceKiosk-H13		
Feature	FaceKiosk-H13A	FaceKiosk-H13C
Attendance Records Capacity	100000	100000
Facial Templates Capacity	10000	10000
Waterproof IP rating	IP65	IP65
Dimensions	323*268*25mm (L*W*H)	354*50*1420mm (L*W*H)
Hardware Modules	MiFare Card, Fingerprint scanner, Ticket Printer, QR Code Scanner	MiFare Card, Fingerprint scanner, Ticket Printer, QR Code Scanner
CPU	Quad-core A17 1.8GH (ZKTeco boosted)	
Operating Frequency	1.8GHz	
Operating System	Android 5.1.1	
RAM	2GB DDR3	
ROM	16GB	
Ports	1*RJ45, TF card slot, 1*HDMI, RS232/485	
Pictures		

1.2 Installation Set-up

1.2.1 Safety Precautions

- Keep the device away from water or dampness. Prevent water or moisture from entering the chassis of the kiosk.
- Ensure proper ventilation of the equipment room and keep the ventilation vents of the kiosk free of obstruction.
- Make sure that the operating voltage is the same one labelled on the kiosk.
- Do not open the chassis when the kiosk is operating or when electrical hazards are present to avoid electrical shocks.

1.2.2 Installation Environment

The device must be installed in indoor and adequate clearance is reserved at the air inlet/exhaust vents for heat dissipation.

Feature	Description
Operating Temperature	0°C to 50°C
Operating Humidity	<90% RH
Storage Humidity	20% to 90% RH

1.2.3 Installation Procedure

Make sure that the Kiosk is installed as per the installation instructions. If you want to open the chassis, you should contact the agent for permission. Otherwise, you will bear any consequence resulting from your actions.

Wall Mounted Device – H13A:

Before installation, connect the wire to the device and pass it on through the lower aperture of the device.

1. Align the back plate with respect to the screw holes on the back of the device.

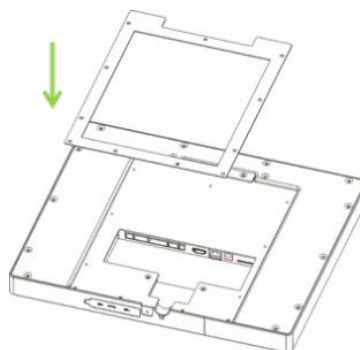

- Secure the plate with screws (11 pcs) to the back of the device

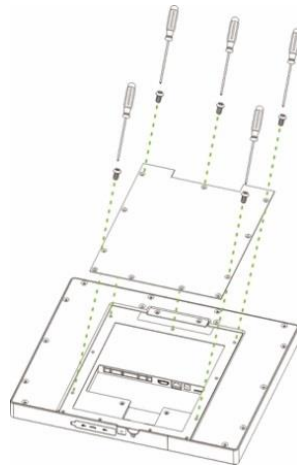

- Make sure that the rear panel is placed at a desirable height on the wall. Drill the holes on the wall and fix the rear panel with screws.

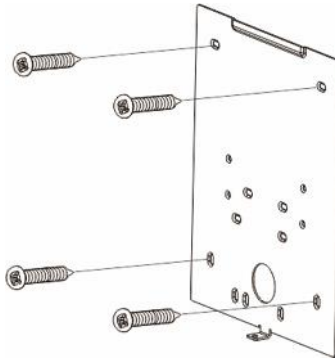

- Affix the device to the rear panel.

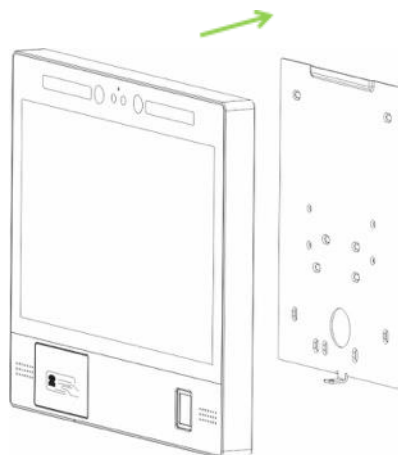

- Secure the device and the rear panel with a screw at the bottom.

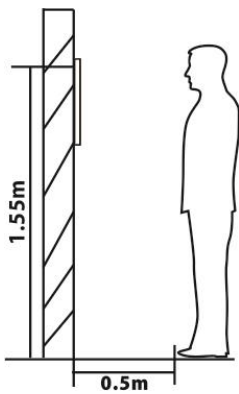
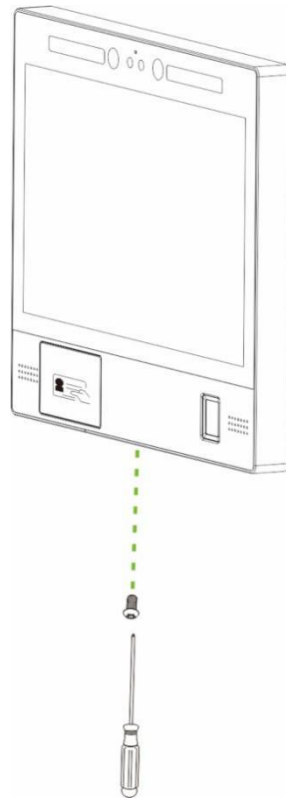

The recommended distance from the camera to the ground is 155cm. The recommended distance from the person to the device is 50cm (applicable height range is 150cm-180cm). If the person's height is not within this range, the front and rear positions can be moved accordingly.

Floor Mounted Device-H13C:

1. Open the device box, remove the Device and the base. Insert the device into the corresponding slot of the base.

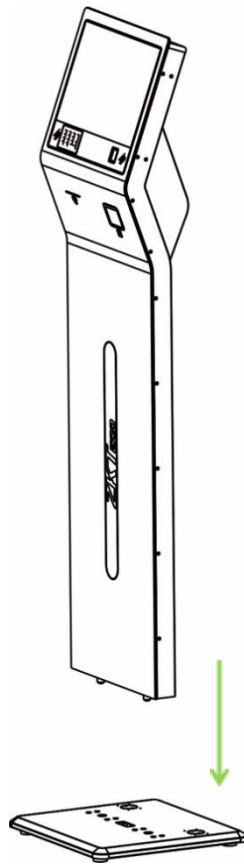

2. Gently recline the device horizontally and secure the device to the base with screws (8 pcs) from the bottom of the base.

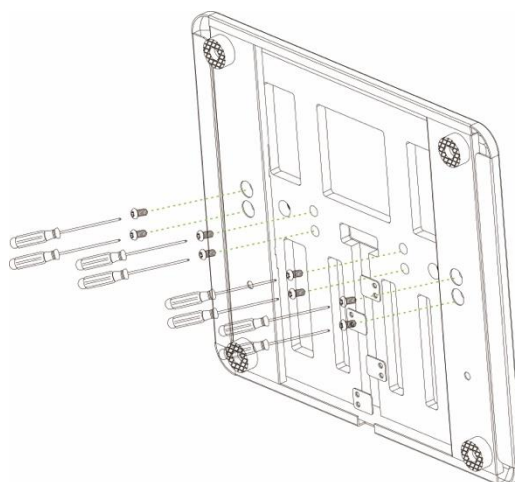

1.3 Product Appearance

FaceKiosk-H13A:

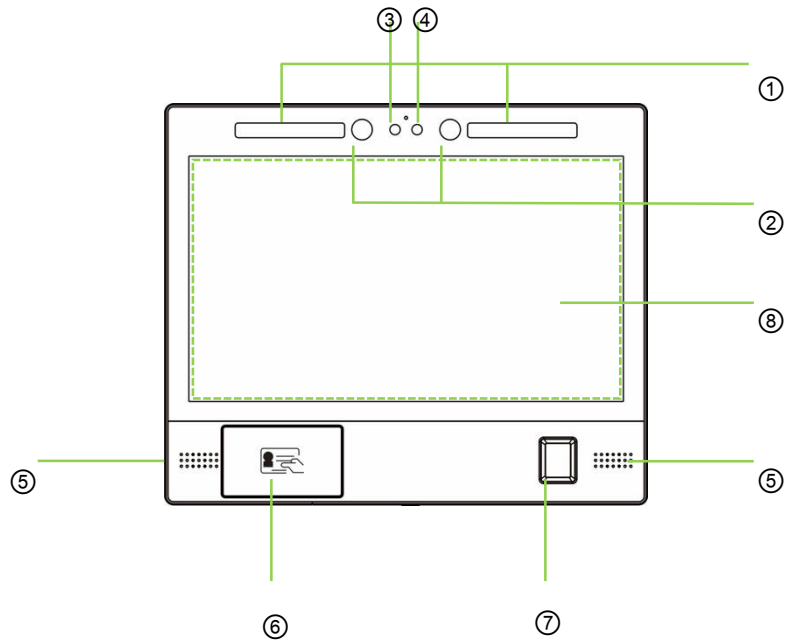

①	LED Fill Light	⑤	Speakers
②	Near Infrared Fill Light	⑥	Mifare Card Module
③	Visible Light Camera	⑦	Fingerprint Reader
④	Near Infrared Camera	⑧	13.3-inch High-definition Capacitive Touch Screen

FaceKiosk-H13C:

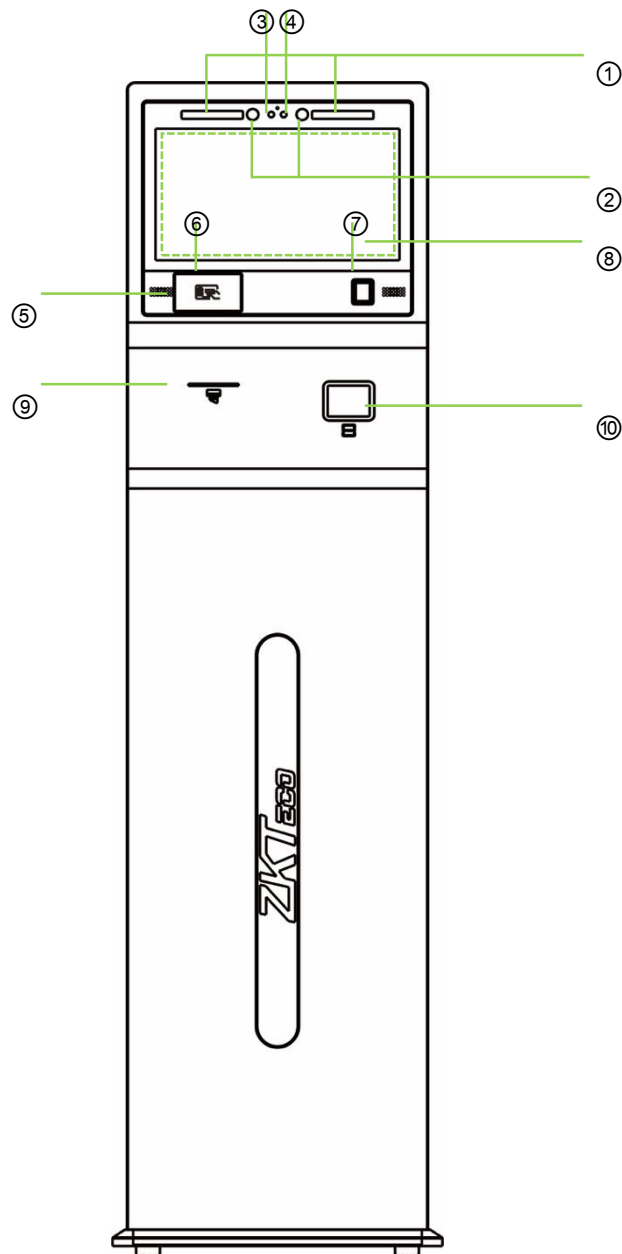

①	LED Fill Light	⑥	MiFare Card Module
②	Near Infrared Fill Light	⑦	Fingerprint Reader
③	Visible Light Camera	⑧	13.3-inch High-definition Capacitive Touch Screen
④	Near Infrared Camera	⑨	Ticket Printer
⑤	Speakers	⑩	QR Code Scanner

1.4 Product Interface

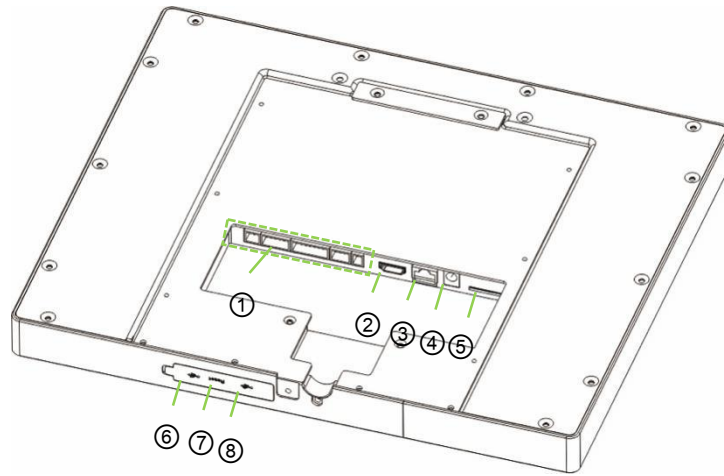

①	Connecting Terminal	⑤	SIM Card Slot
②	HDMI Port	⑥	USB Port
③	Network Port	⑦	Reset Button
④	12V-3A Power Interface	⑧	USB Port

1.5 Device Connection

There are 5 rows of slots on the back of the device, which are J1, J2, J3, J4 and J5 from left to right. J1 is connected to the alarm, J2 is connected to the door, J3 is connected to the external device, J4 is connected to the Wiegand input, and the J5 is the power output port reserved for a Printer.

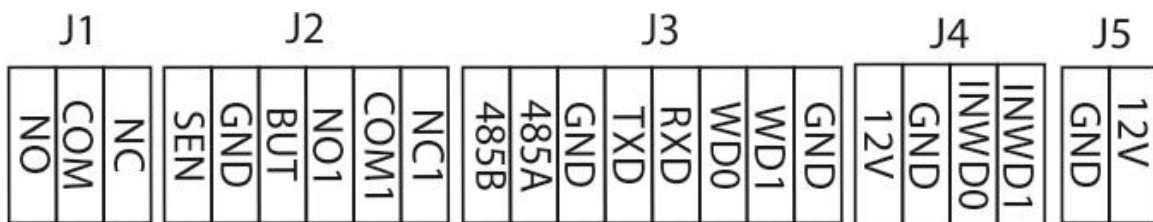
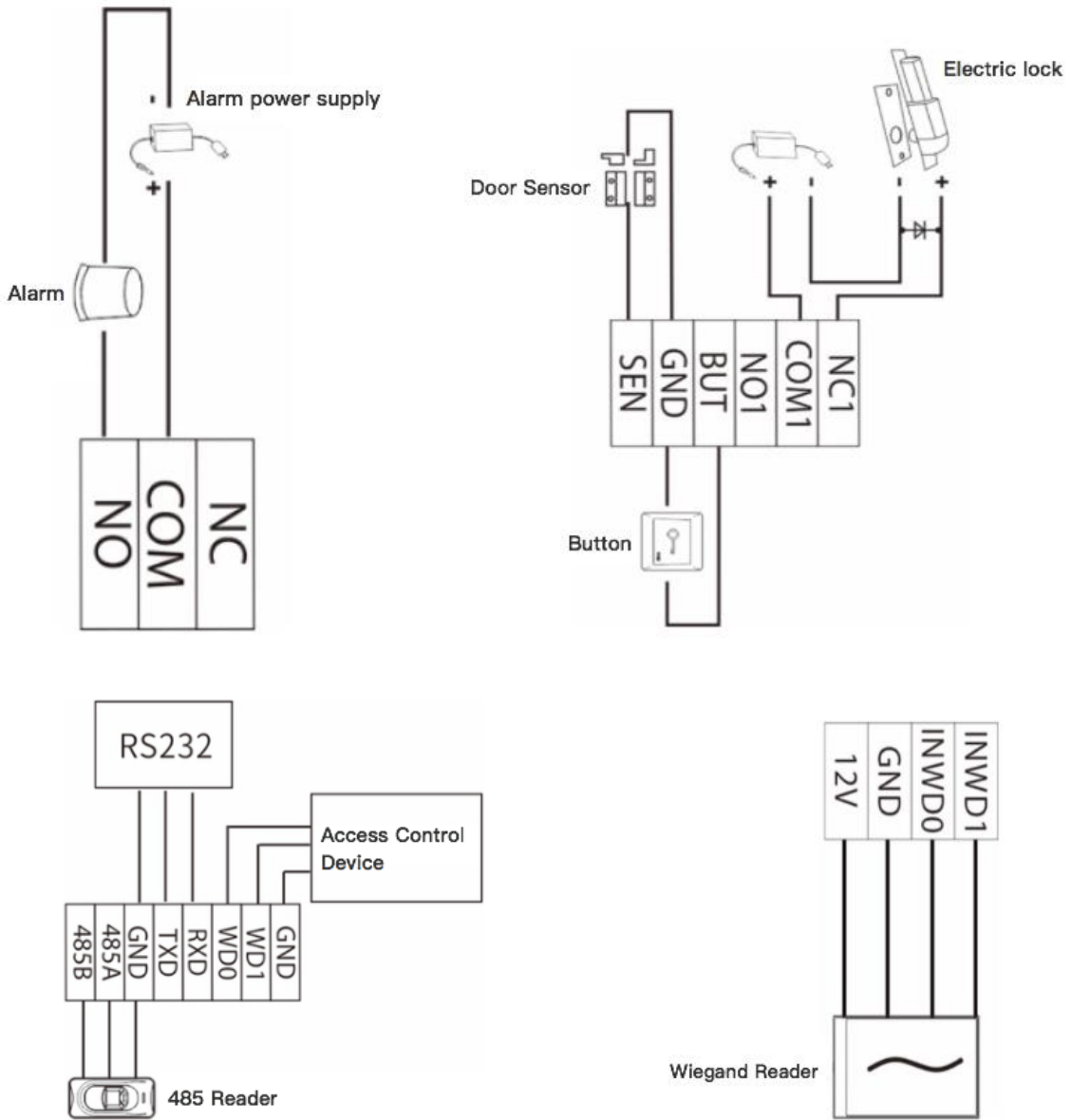

Diagram:



2 Home Screen and Main Menu

The home screen is divided into the following sections:





Title bar: It displays the **Name of the device** and the **Main menu** button.

Monitoring screen: It displays the picture captured by the camera. Once the face is detected, it will be captured within the capture area and the verification result will be popped-up.

Status: It displays the details of the person and the verification result.

Description of Icons in Home screen:

Main Menu: Tap on  to open the Main menu.

Record Search: Tap on  to open the Attendance records

Language: Tap on  to change the System language.

TTS Setting: Tap on  to edit the TTS broadcasting contents.

AD Player: Tap on  to turn on the Advertisement player and select the Advertisement pictures and videos.

2.1 Main Menu

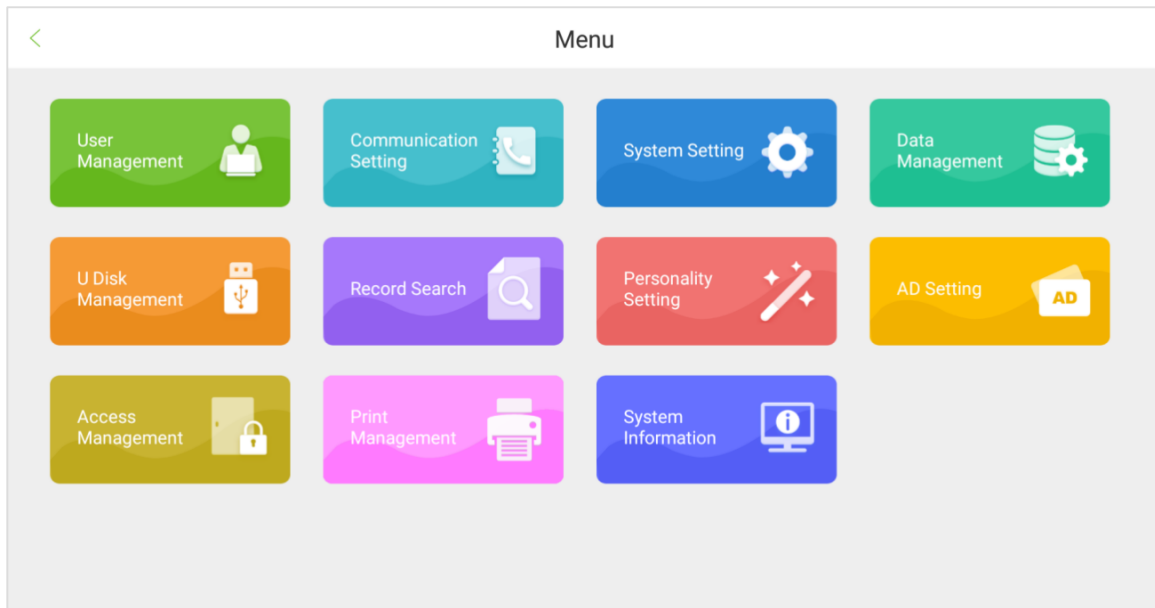

Menu	Function
User Management	Enables to View, Add, Edit, Search and Delete the basic employee information.
Communication Setting	Facilitates to set the communication parameters such as the Network, Wi-Fi, and PUSH.
System Setting	Allows setting the System parameters including, Time & Date, Face parameters, Attendance parameters, Settings for strangers, Settings for blacklisted employees, and QR code address settings.
Data Management	Managing data includes Data backup, Data restoration and clearing data.
U Disk Management	Uploads or downloads the data through a USB drive.
Record Search	Displays Attendance records, Meeting details, Blacklisted data, Stranger's photo, etc.
Personality Setting	Sets Voice broadcast, Sleep time of the device, Display style of the status bar and special effects for VIP, etc.
AD Setting	Plays the Advertisement, sets the advertising frequency, etc.
Access Control Management	Sets the Access control parameters and Wiegand functions.

Print Management	Sets the Printer parameters such as printing object content, printing format, etc.
System Information	Displays the device information such as Data capacity, Firmware version, Android version, etc.



If the Super Administrator is not registered for the device, then click  to access the main menu. If the device has a Super Administrator, then his/her verification is required to access the main menu. For security considerations, you are advised to register an Administrator while using the device for the first time.

3 Employee Management

Open the main menu and select **User Management**. The employee's list will be displayed, showing the basic information of all the employees, including their Names, Employee ID's, and their pictures, as shown in the below image:

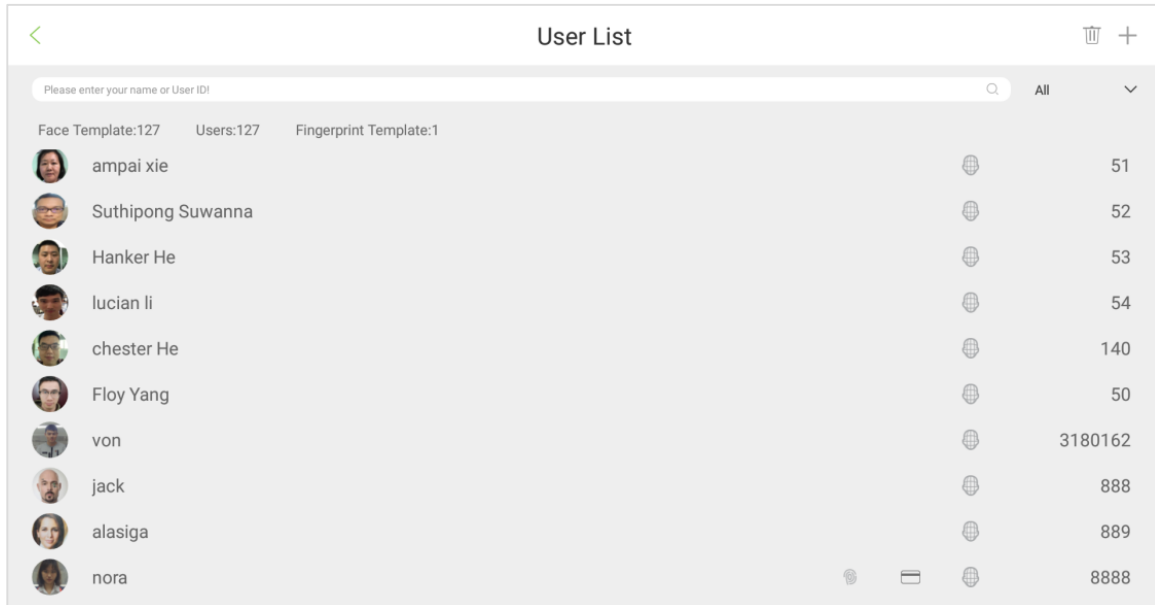

3.1 Add an employee

Click < in the upper left corner of the screen to return to the employee list screen. Click  in the upper right corner to add a new user as shown in the below image:

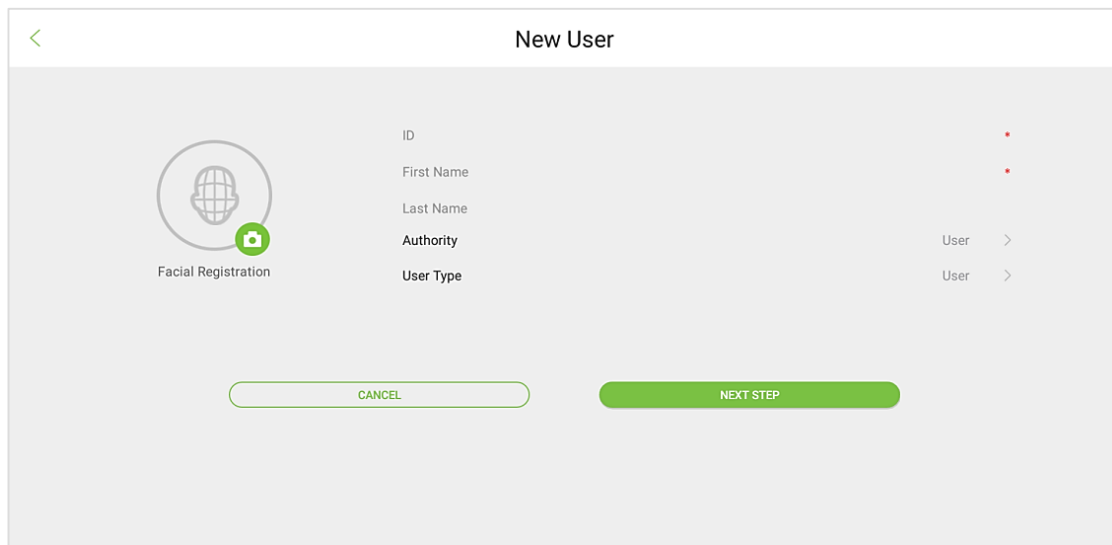

Description of the fields:

ID: Enter the ID of the employee. It supports numbers from 1 to 9 digits by default. The message "**Duplicated ID, please enter again.**" indicates that the ID number you have entered is already being used. Please enter another ID.

Username: The username refers to the Employee's name. Its maximum length is 24 characters.

Authority: It includes a Normal user and an Administrator. After configuring an Administrator, administrator verification is required to access the main menu. An administrator can set up a password maximum of 6 digits.

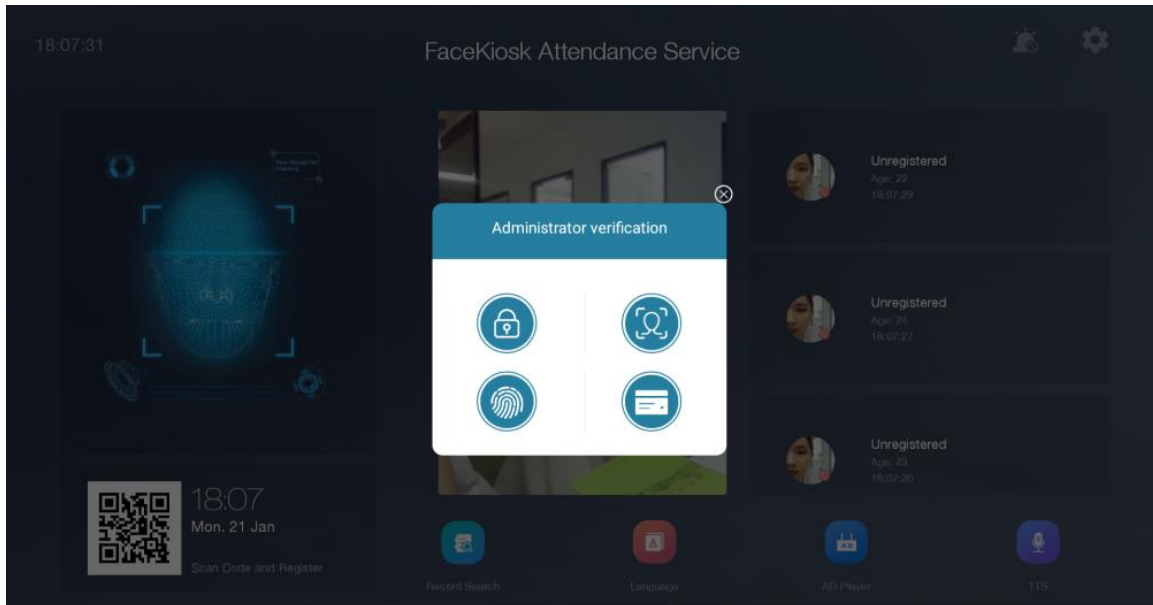

Identity Type: It includes Normal, VIP and Blacklist. The normal identity type is for the attendance recording of normal employees. The pop-up window varies for VIP and Normal Employees after verification. These special effects can be set in [Personality settings](#).

If an employee is blacklisted, he/she cannot open the door by facial recognition. Photo capturing and alarm functions for blacklisted employees can be set in [System settings](#).

Verification Method:

After entering the employee's basic information, tap on **Next** to select the verification method.

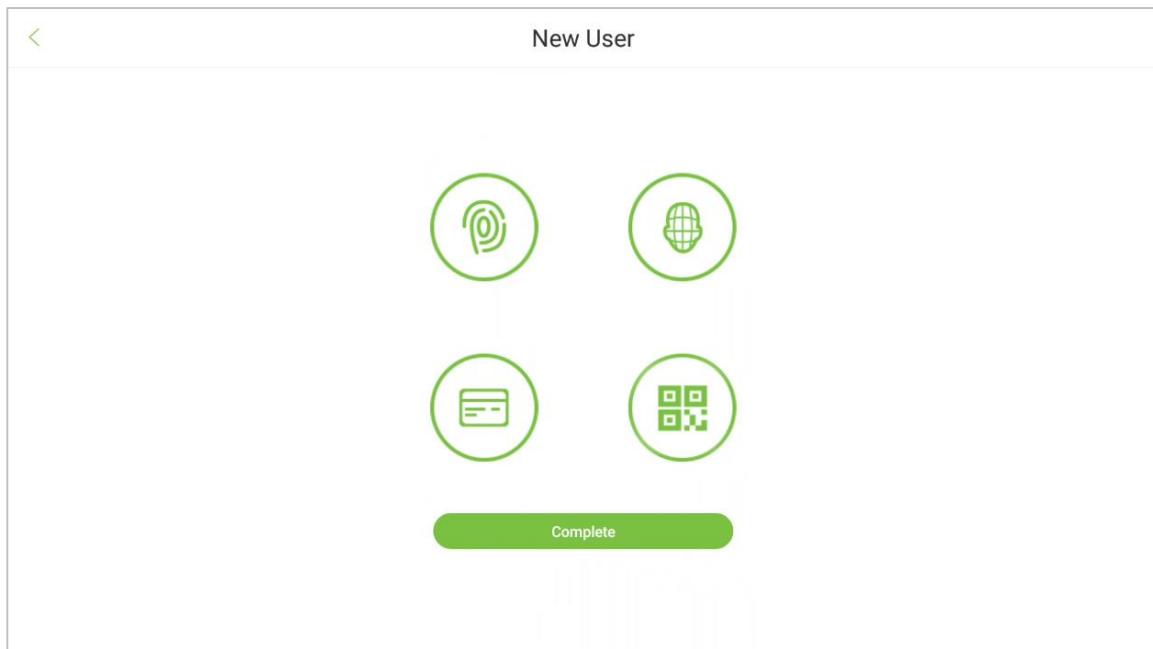

Face Registration:

Tap on  icon and then stand in the monitoring area. When your face is identified, the registration is successful, and your photo will be saved.

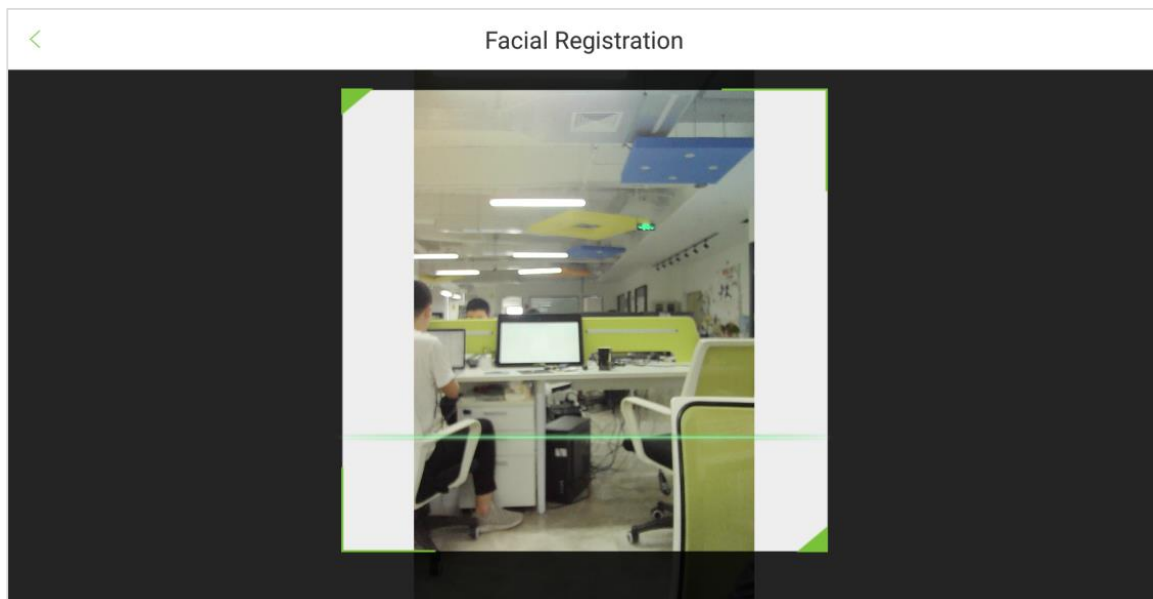

Fingerprint Registration:

1. Tap on  icon to open the fingerprint registration page. Tap on the finger for which you would like to register the fingerprint.

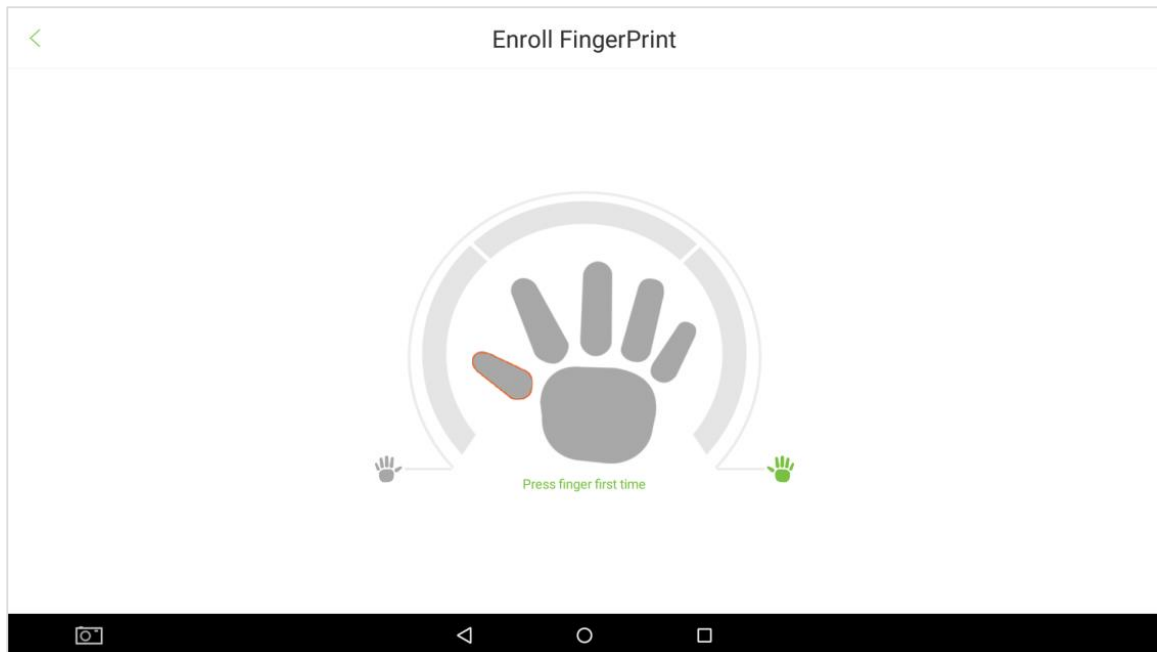

2. Press your finger repeatedly until you see a Green indicator which denotes successful registration. If you press different fingers onto the fingerprint scanner on successive verifications, the prompt appears as **"Please use the same finger"**.
3. Once the fingerprint is registered successfully, a dialog box appears as "Continue to enroll the next fingerprint?". Tap on **Yes** to register the next fingerprint, or **No** to return to the fingerprint registration page.

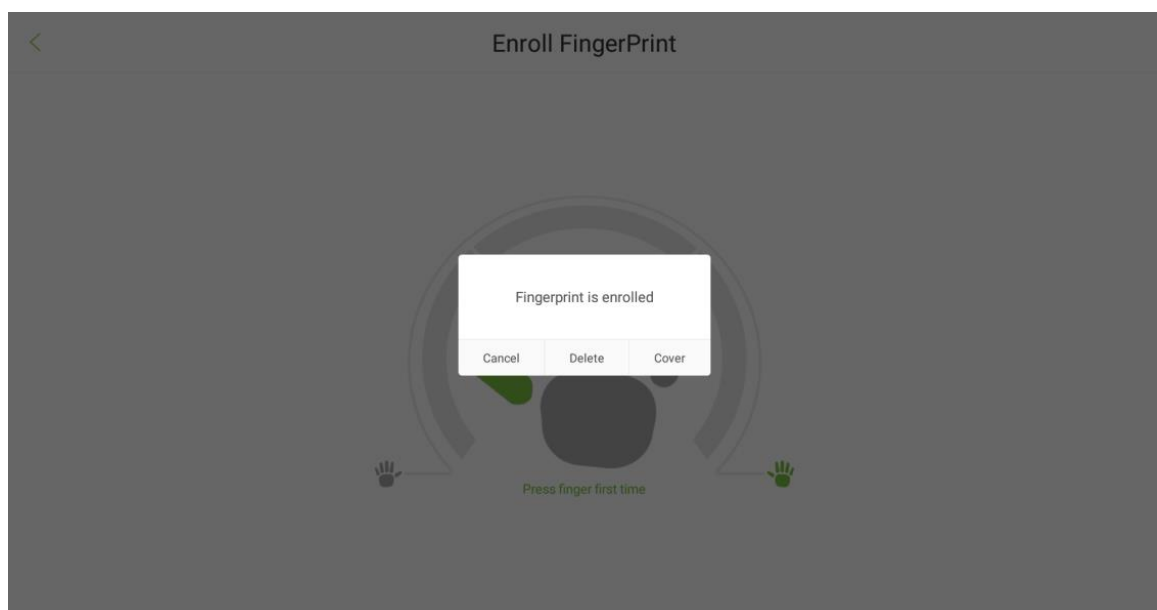

Badge Registration:

Tap on  icon to open the badge number registration page. Place your badge close to the card swiping area.

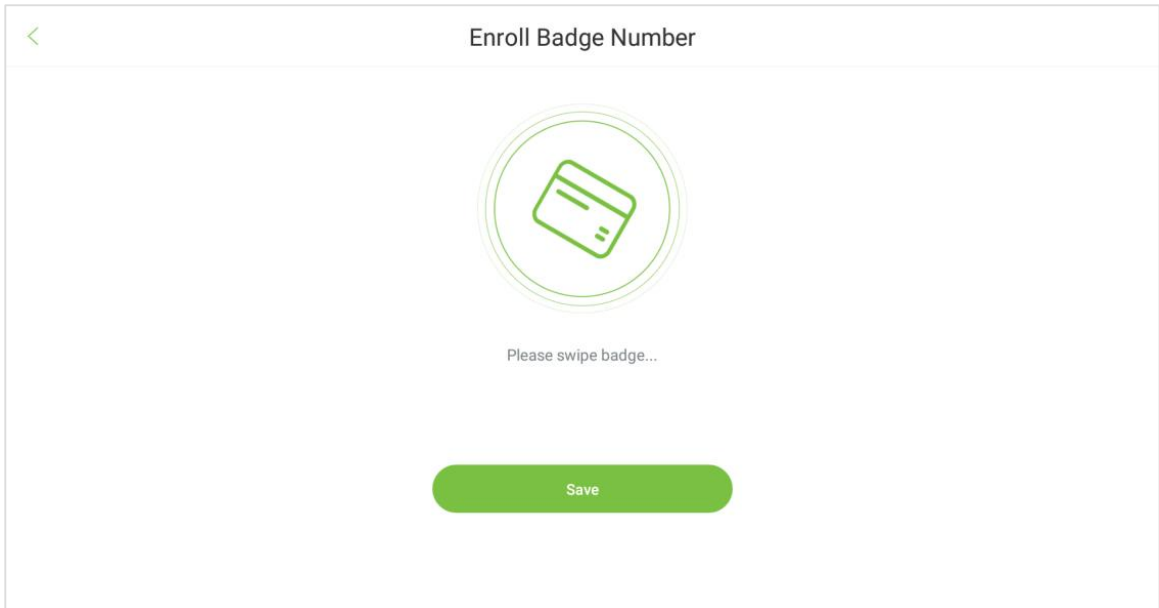

Barcode Registration:

Tap on  icon to open the barcode registration page. Place your QR code in front of scanner area.

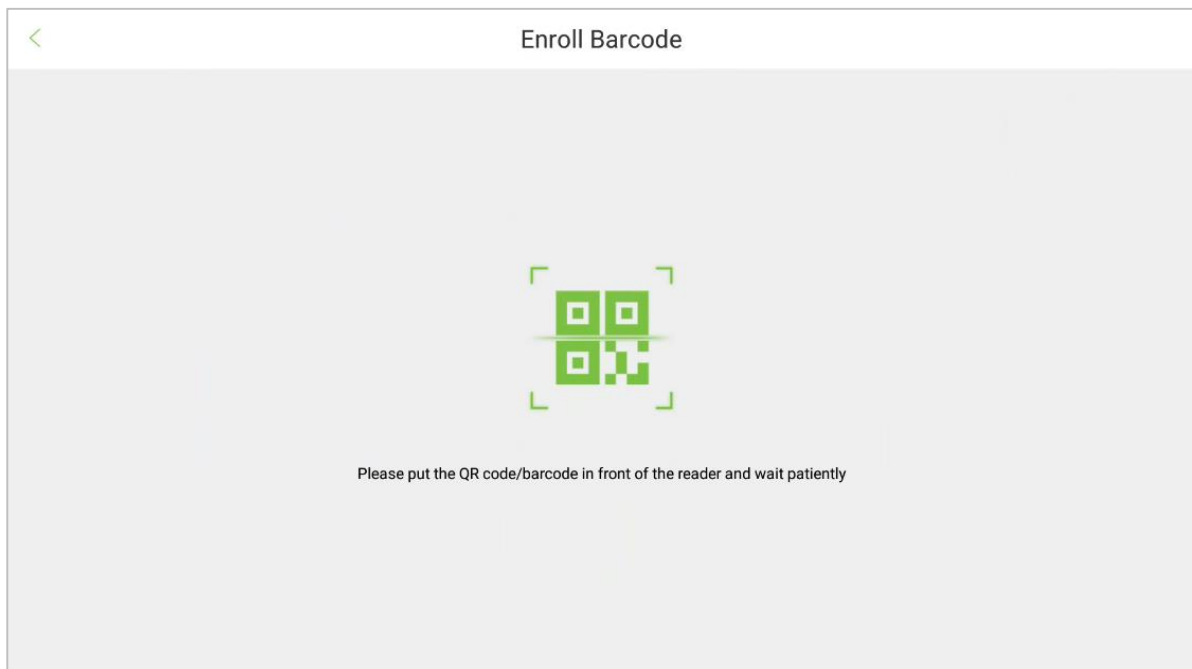

Verification Mode Setting

To improve security, this device offers the feature of using multiple verification modes. A total of 15 different verification combinations can be used, as shown below:

Verification Mode	
<input checked="" type="radio"/>	FingerPrint/Badge/Face
<input type="radio"/>	FingerPrint
<input type="radio"/>	Badge
<input type="radio"/>	Face
<input type="radio"/>	FingerPrint/Badge
<input type="radio"/>	FingerPrint/Face
<input type="radio"/>	Badge/Face
<input type="radio"/>	FingerPrint+Badge
<input type="radio"/>	FingerPrint+Face
<input type="radio"/>	Badge+Face
<input type="radio"/>	FingerPrint+Badge+Face
<input type="radio"/>	Barcode



Explanation of verification combinations:



1. "/" means "or". E.g.: Fingerprint verification or Badge verification is valid
 "+" means "and". E.g.: Fingerprint verification and Badge verification both are required.
2. Combined verification requires the employees to register the information needed to complete the verification. Otherwise, employees may not be able to complete the verification process. For instance, when an employee A registers with his/her fingerprint data, and the system's verification mode is set as "Fingerprint + Face", the employee will not be able to complete the verification process.

The example below shows "Fingerprint + Badge +Face" verification. To log in to the system, please follow these steps:

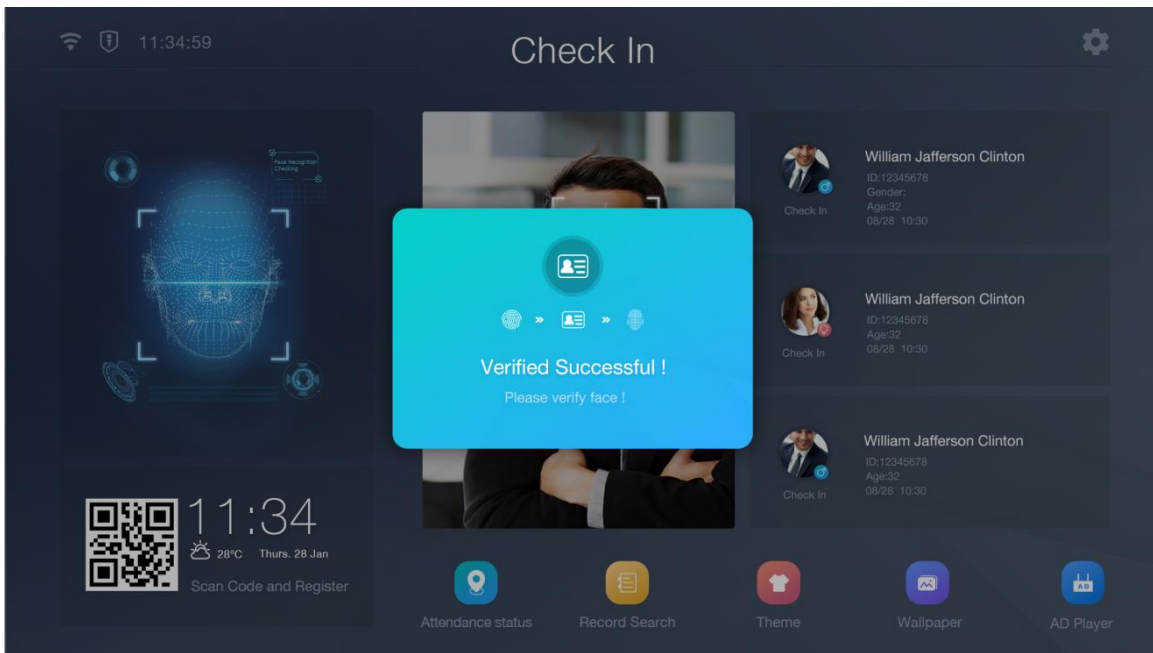
Press your finger on the Fingerprint reader and swipe the badge. Then the face verification window will appear. Then verify your face to complete the entire verification process. The verification sequence is Fingerprint → Badge → Face.



3.2 Delete an employee

- Tap on  in the upper right corner to initiate the deletion process.
- Select the employee to be deleted and tap on  icon.

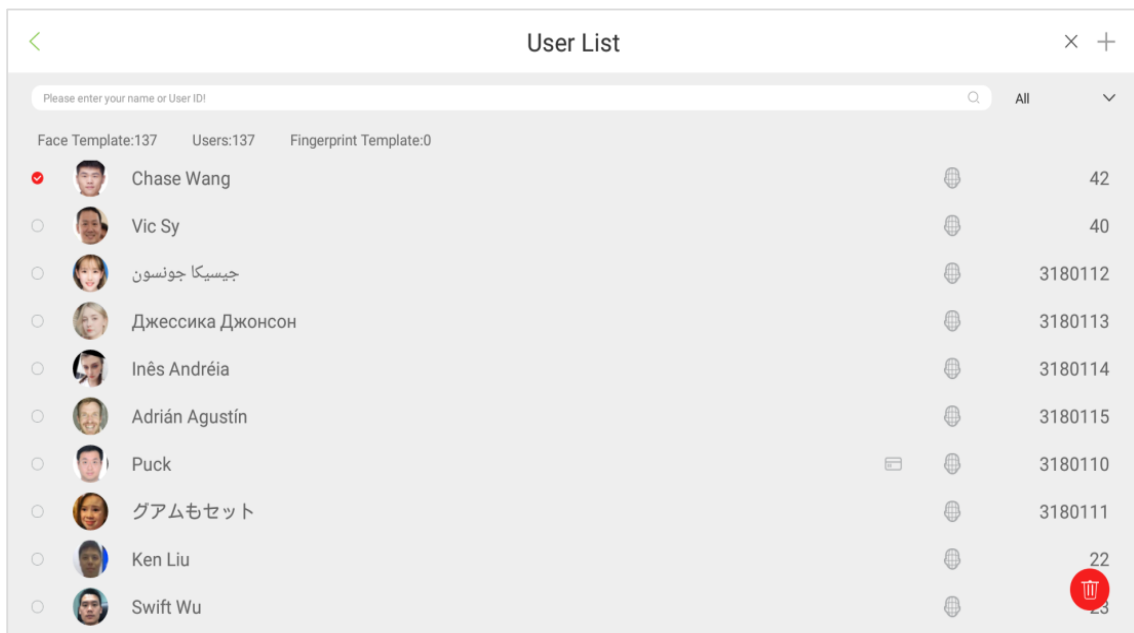

4 Communication Settings

To enable the communication between the device and the PC over a network, it is necessary to set the communication parameters on the device.

4.1 Wi-Fi Settings

Open **Communication Setting** → **Wi-Fi** to set Wi-Fi parameters.

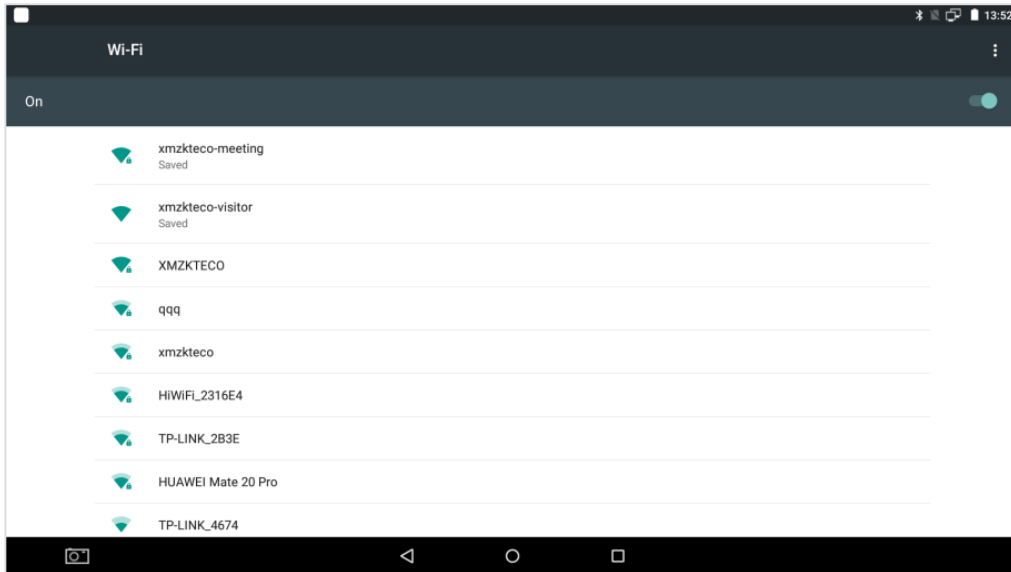

4.2 Ethernet Settings

Open **Communication Setting** → **Ethernet** to set the LAN parameters.



Field	Function
-------	----------

Ethernet	Enable/Disable the Ethernet connection.
IP Address	The default IP Address is 192.168.1.201.
Subnet mask	The default subnet mask is 255.255.255.0.
Gateway	The default gateway address is 0.0.0.0.
DNS	The default address is 0.0.0.0.
DHCP	Assigns dynamic IP Addresses to the network clients over a Server.
IP Mode	Displays the mode of IP Address. It can be static or dynamic.

4.3 Server Settings

Open **Communication Settings** → **Cloud Server Setting** to set the parameters for connecting the PUSH Server.

<
Cloud Server Setting

Please enter server type ZKBioSecurity >

Domain Name Server

Please enter server address 0.0.0.0

Please enter server port 0

Field	Function
Server type	Select the software you want to connect: E.g.: BioTime, ZKBioSecurity.
Domain Name Server	Enable the Domain Name Server.
Server Address	Set the Server IP address of the software.
Server Port	Set the Server Port of the software.

5 System Settings

On the main menu screen, tap on **System Setting** to set the system parameters based on your requirements.

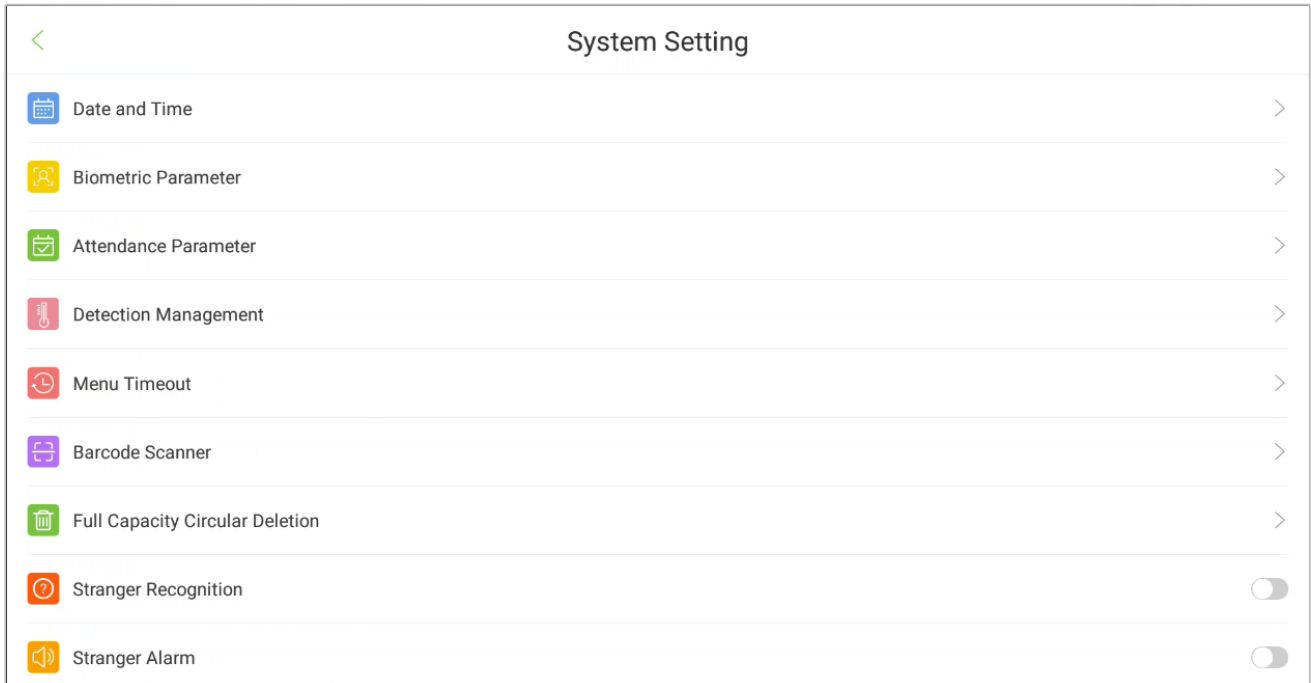

5.1 Time and Date

Open **System Setting** → [Date & time].

The user can set the date and time in two ways.

Set network time:

The time and date will be synchronized with network time , check the network connection before set this mode

Set server time:

The time and date will be synchronized with server time , check the server connection before set this mode. The server connection can be set in [Communication Setting](#).

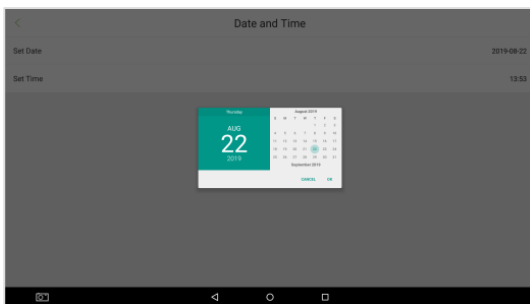
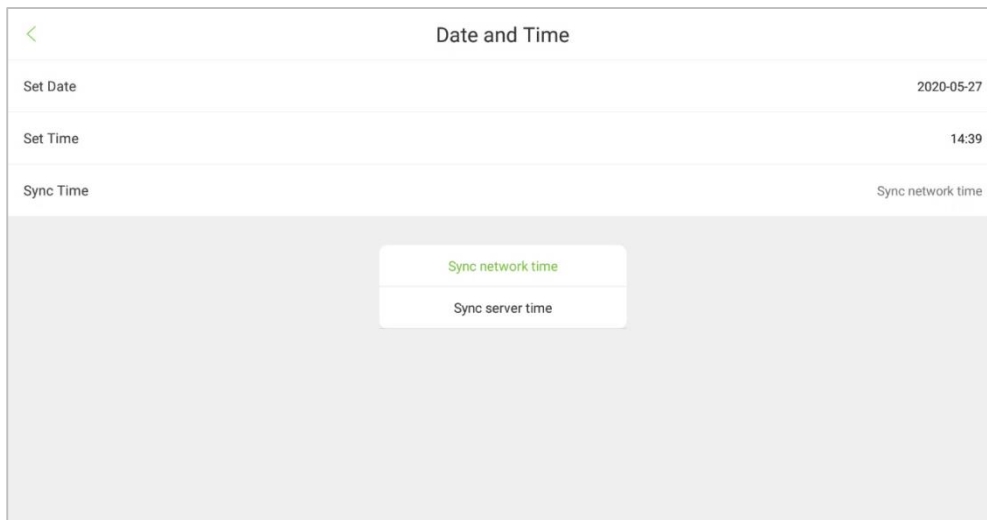

Select the Date, Month and year in the calendar and then tap on **OK**.

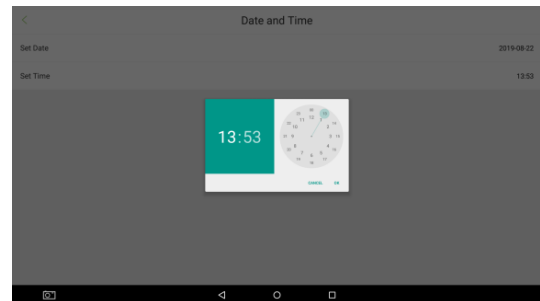

Move the Hour and Minute hands to set the time.

5.2 Biometric Parameter

Open **System setting** → **Biometric parameter** to set the biometric parameters.

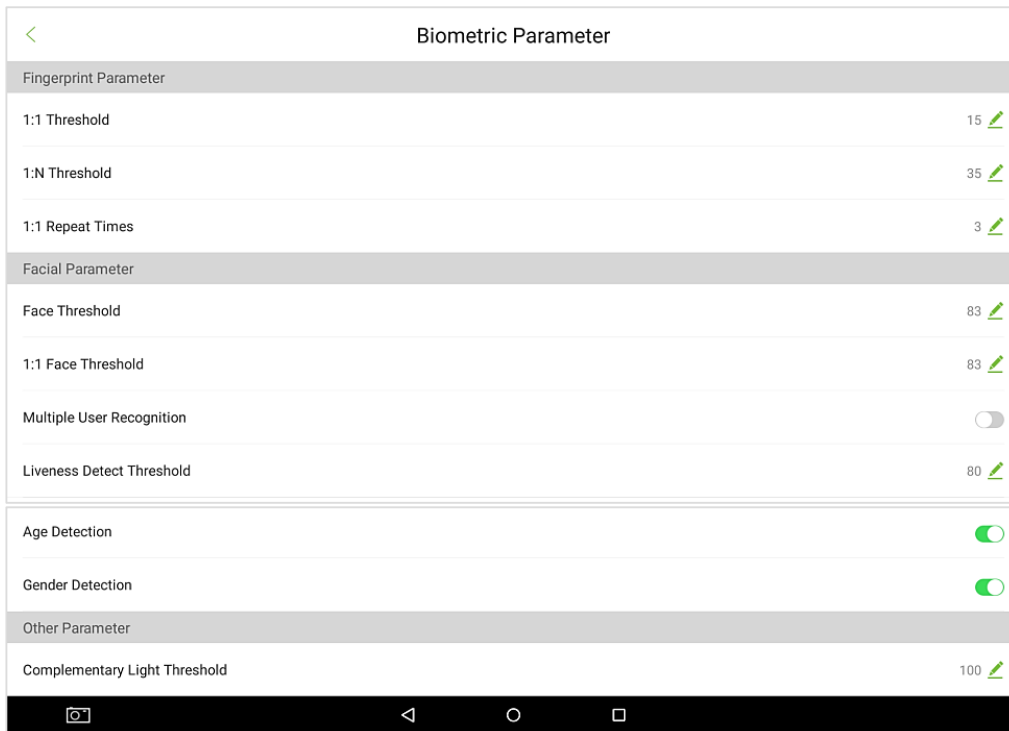

Description of the fields:

1:1 Fingerprint Threshold: While executing 1:1 fingerprint verification, the fingerprint data is collected and instantly compared with the registered fingerprint data using the 1:1 algorithm. This is converted into value and then compared to a preset value. If the value of the scanned fingerprint exceeds the preset value, the verification is valid. If it does not, the verification fails.

1: N Fingerprint Threshold: While executing 1: N verification, the fingerprint data is collected and instantly compared with all the fingerprint templates on the system using the 1:N algorithm. This is converted into value and then compared to a preset value. If the value of the scanned fingerprint exceeds the preset value, the verification is valid. If it does not, the verification fails.

1:1 Repeat Times: This denotes the maximum allowed number of failed verifications under 1:1 verification. When the number of failed verifications reaches this value, the system will return to the standby interface.

Face Threshold: Sets the level of similarity between the registered face templates and the verified one in the device. The default value is 83, and it ranges from 76 to 86.

1:1 Face Threshold: While executing 1:1 face verification, the face data is collected and instantly compared with the registered face data using the 1:1 algorithm. This is converted into value and then compared to a preset value. If the value of the scanned face exceeds the preset value, the verification is valid. If it does not, the verification fails.

Multiple User Recognition: If selected, the device supports multiple recognition function. Once enabled, 4 to 6 persons can be recognized at the same time. It's not recommended in access control environments.

Liveness Detection threshold: A lower value leads to higher accuracy with a higher rejection rate. But the recognition speed will be influenced. The recommended value is 80, and it ranges from 0 to 99.

Age Detection: If selected, the device supports user age detection. Once enabled, the check-in interface and the attendance record will display the detected results of the identified users.

Gender Detection: If selected, the device supports user gender detection. Once enabled, the check-in interface and the attendance record will display the detected results of the identified users.

Complementary Light Threshold: Detects the ambient light brightness. When the brightness of the surrounding environment is less than the threshold, the complementary light is turned on. When the brightness is greater than the threshold, the complementary light is turned off. The default value is 100.

5.3 Attendance Parameters

Open **System Setting** → **Attendance Parameter** to self-define the attendance parameters. The interface is as follows:

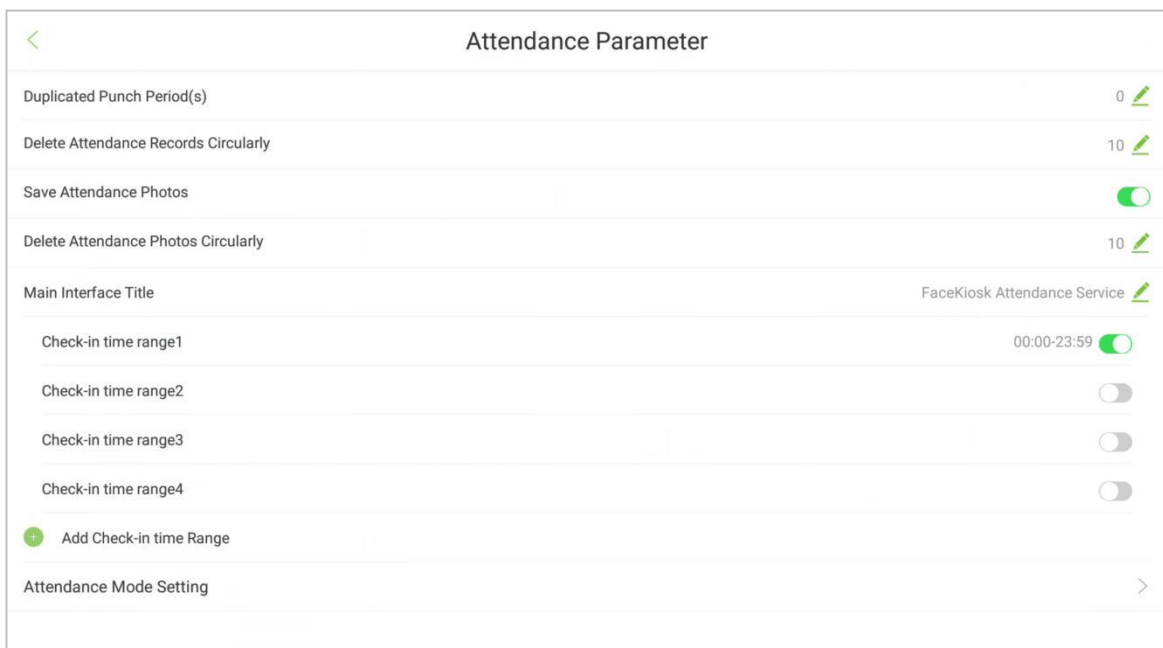

Description of fields:

Duplicate punch period: User can set a time-period, in which the repeated attendance record of the same employee will not be considered. The range is 0-9999. (unit: second)

Delete Attendance Record Circularly: It indicates the duration as far as the attendance records will be saved. That means, when the attendance record reaches the maximum capacity, the system deletes the earliest records in a cycle. The maximum capacity of attendance record is 100,000. The range is 0-99999. 0 indicates that the records will not be deleted.

Save Attendance Photo: Enable if you want to save the captured attendance photo after face verification. By default, this feature will be disabled.

Delete Attendance Photo Circularly: When attendance photo reaches the maximum capacity, the device deletes the earliest attendance photo in the cycle. The maximum capacity of the attendance photo is 10,000. The range value is 0-9999. 0 indicates that the records will not be deleted.

Main Interface Title: Set the display title of the Face Kiosk device. (The default content is Face Kiosk Attendance Service).

Check-in Time range: The face appearing in the monitoring area will not be identified if the device is not within the check-in time range. It has 4 check-in time ranges by default. Apart from that 5 check-in time ranges can be added.

Attendance Mode Setting: Set the attendance mode of the device.

5.3.1 Attendance Mode Setting

Open **System Setting** → **Attendance Parameter** → **Attendance Mode Setting** to set the attendance modes.

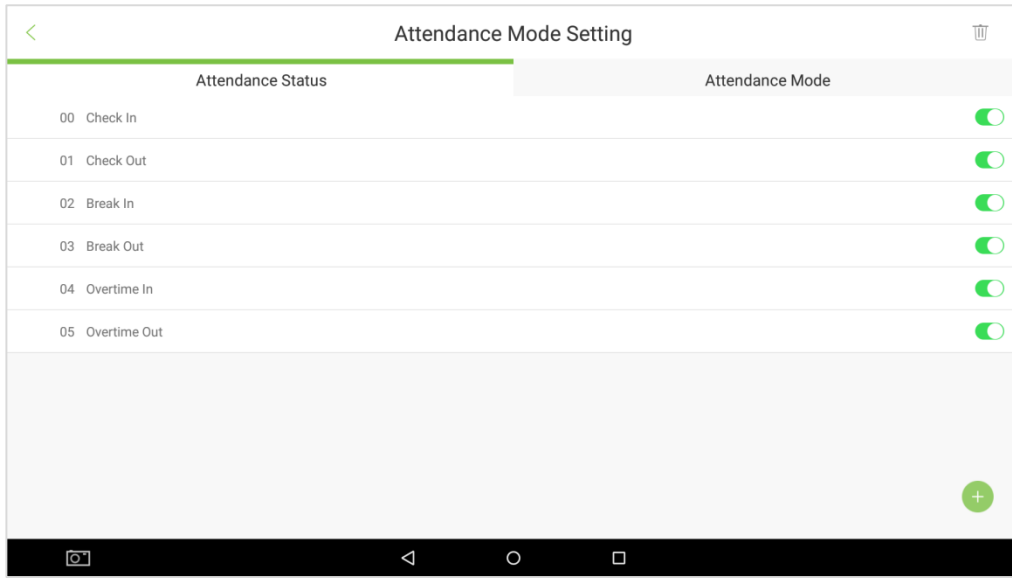

Attendance Status

Attendance status is used to record the check-in/out status. There are 6 default attendance statuses, including check in, check out, break in, break out, overtime in, overtime out. The 6 default statuses can be modified but cannot be deleted.

1. On the **Attendance Status** interface, tap on  to create a new status.

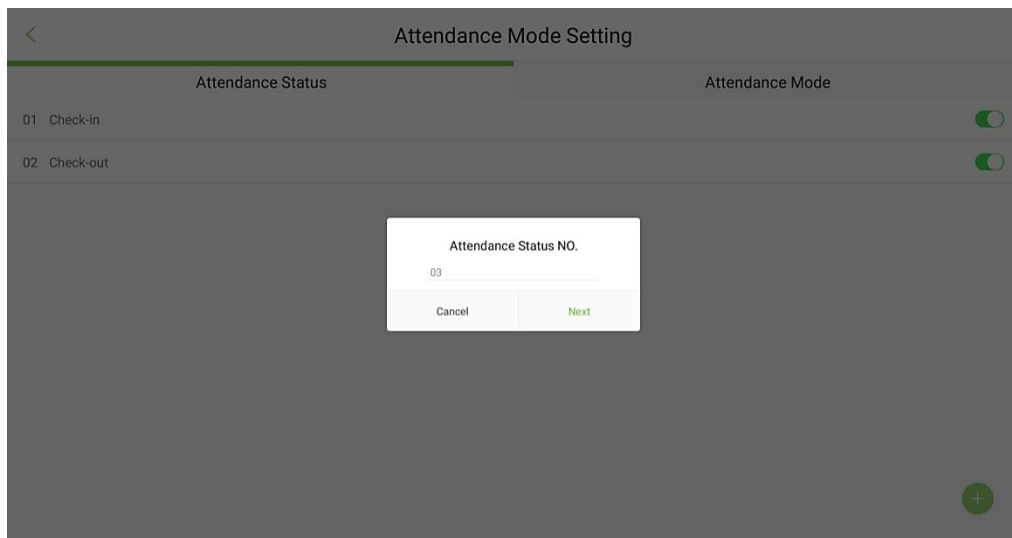

2. Enter the **Name** and **Number** of the new attendance status.

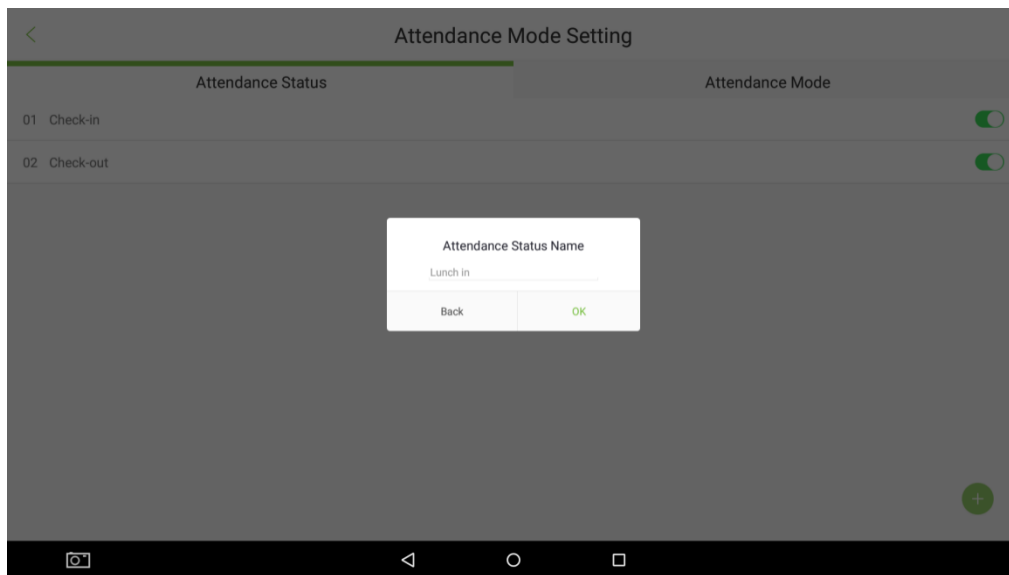

 The maximum supported length of the Name is 50 characters. The status numbers must be unique and cannot be duplicated. The range is from 0 to 9999.

Attendance Mode

There are three modes for attendance statuses namely:

- Attendance Status Auto Switch
- Disable mode
- Choosing Attendance Status

Attendance Status Auto Switch:

When this mode is enabled, the attendance status will be automatically updated according to the current time.

1. Tap on **Attendance Status Auto Switch**, and then  icon to open the settings.

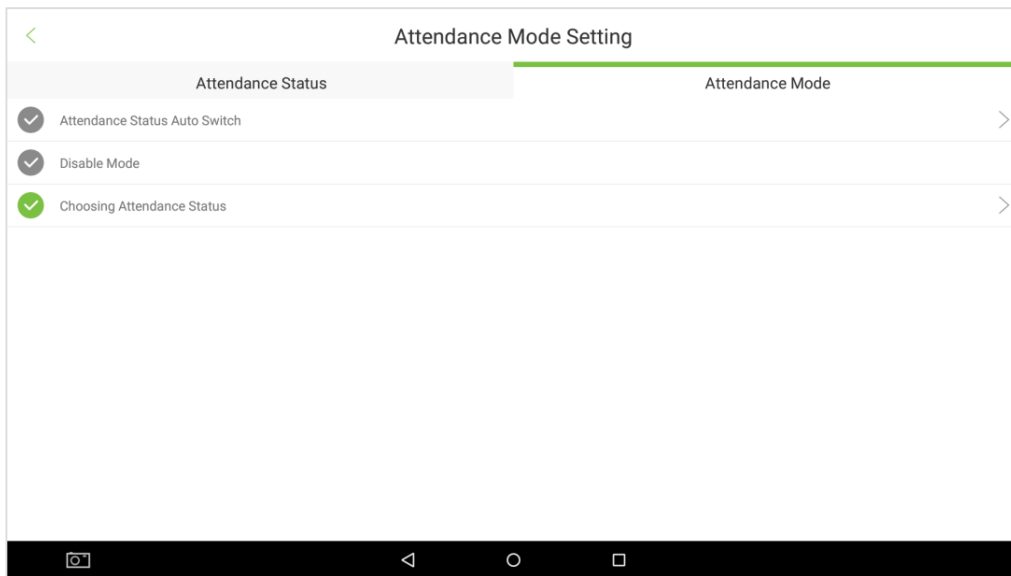

2. Tap on  icon and then scroll to the required time to switch the attendance status.

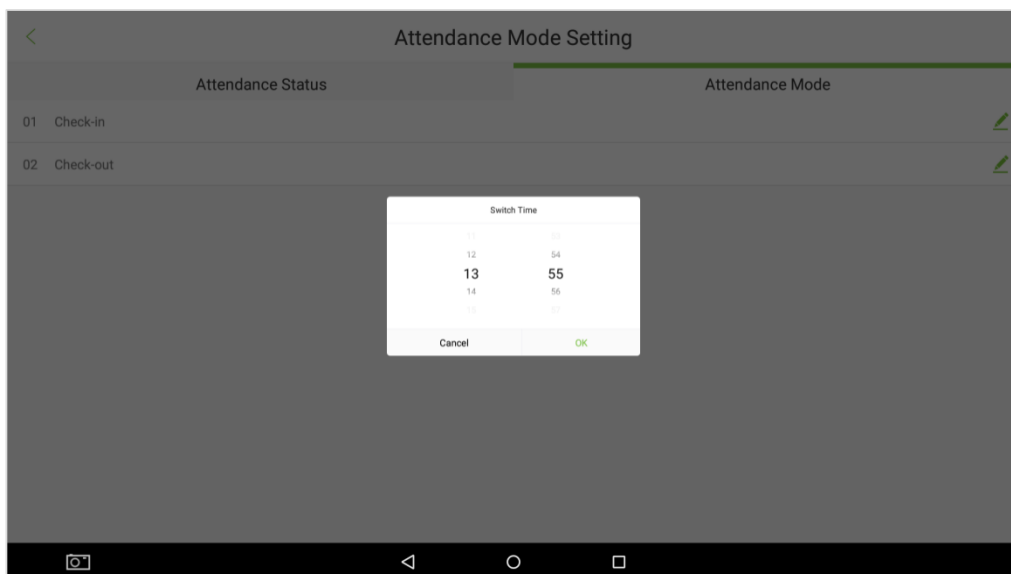

Disable mode: This function is currently not used.

Choosing Attendance Status:

1. Enable at least one status in the **Attendance Status** interface. If all the statuses are disabled, the user would not be able to select this mode.
2. Tap on **Choosing Attendance Status** which enables the employee to select the attendance status after verification.

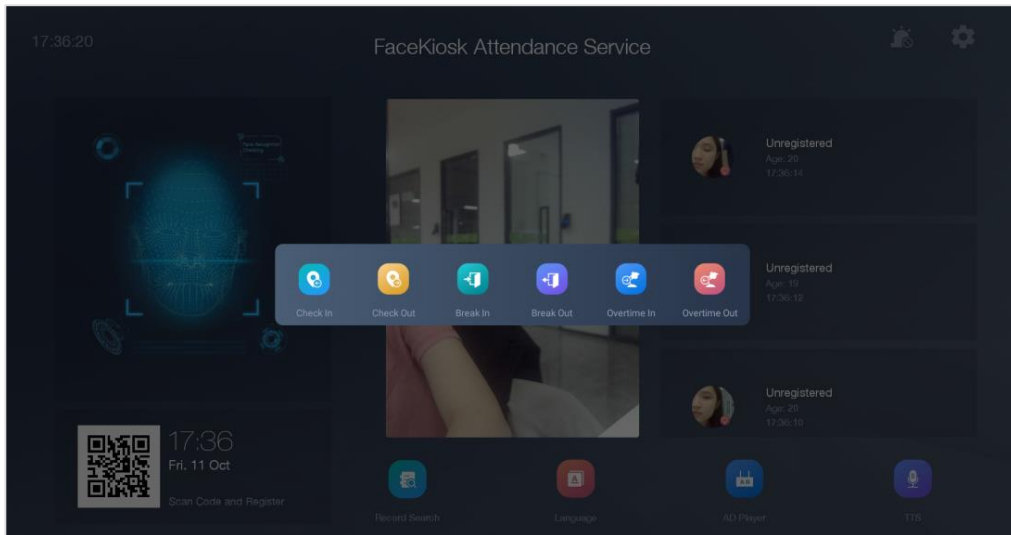

3. The selected status will be saved in the attendance records.

Attendance Record

Please enter your name or User ID

Date	User ID	Status	Time	Gender	Time
2013-01-21	69669	Overtime In	17:49:30	female	17:49:30
	69669	Check In	17:49:25	female	17:49:25
	69669	Check In	17:49:23	female	17:49:23
	69669	Check In	17:49:21	female	17:49:21
	69669	Check In	17:49:14	female	17:49:14
	69669	Check Out	17:48:39	female	17:48:39
	69669	Break In	17:48:37	female	17:48:37
	69669	Break Out	17:48:35	female	17:48:35

5.4 Detection Management

Open **System Setting** → **Detection Management**.

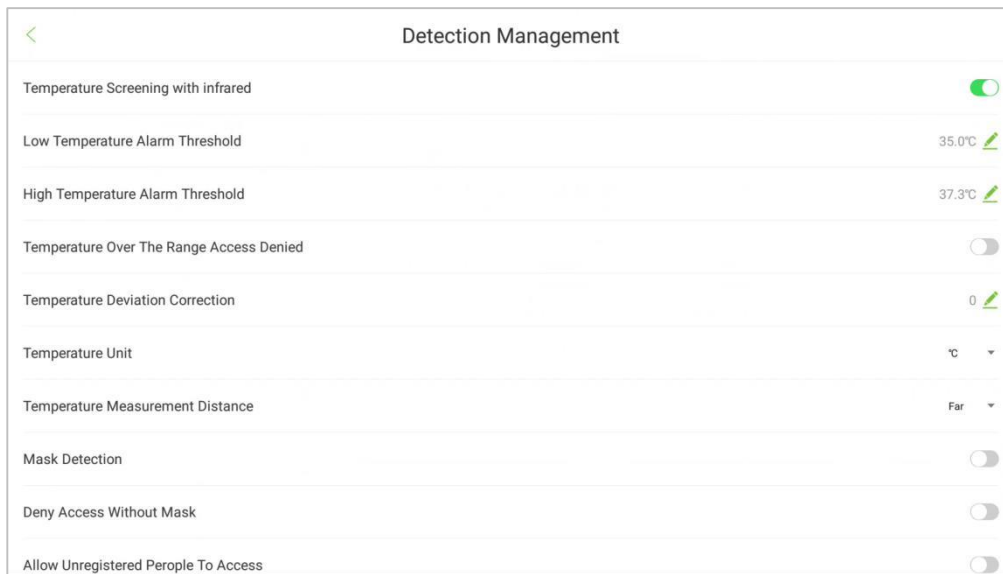

Description of fields:

Temperature Screening with Infrared: When the feature is enabled, the device will screen the body temperature of the detected users and displays in real-time in the camera area.

Low Temperature Alarm Threshold: When the detected temperature is lower than the set value, it will be regarded as invalid data and the temperature will be displayed in white and it will not be included in the final temperature value.

High Temperature Alarm Threshold: When the detected temperature is higher than the set value, the device will trigger an alarm and the temperature will be displayed in red.



Temperature Over the Range Access Denied: When the detected temperature is higher than the high temperature alarm threshold, the device will deny user access.

Temperature Deviation Correction: Set the compensation value of the temperature detection data, it supports entering the positive and negative numbers.

Temperature Unit: You can set the temperature as Celsius or Fahrenheit.

Temperature Measurement Distance: Set the temperature measurement distance as Close / Near / Far.

Mask Detection: When the feature is enabled, the device will detect the mask wearing status of users and displays in real-time on the scanning area.



Deny Access Without Mask: When the feature is enabled, the device will deny the users who do not wear mask to access.

Allow Unregistered People to Access: When the feature is enabled, the device will allow unregistered people to access.

Trigger External Alarm: When the feature is enabled, the device will be able to trigger an external alarm.

5.5 Menu Timeout

Open **System Setting** → **Menu Timeout**.

When an Administrator logs into the device and no operation is performed within the menu timeout period, the device will automatically switch to the home screen.



5.6 Full Capacity Circular Deletion

Open **System Setting** → **Full Capacity Circular Deletion**

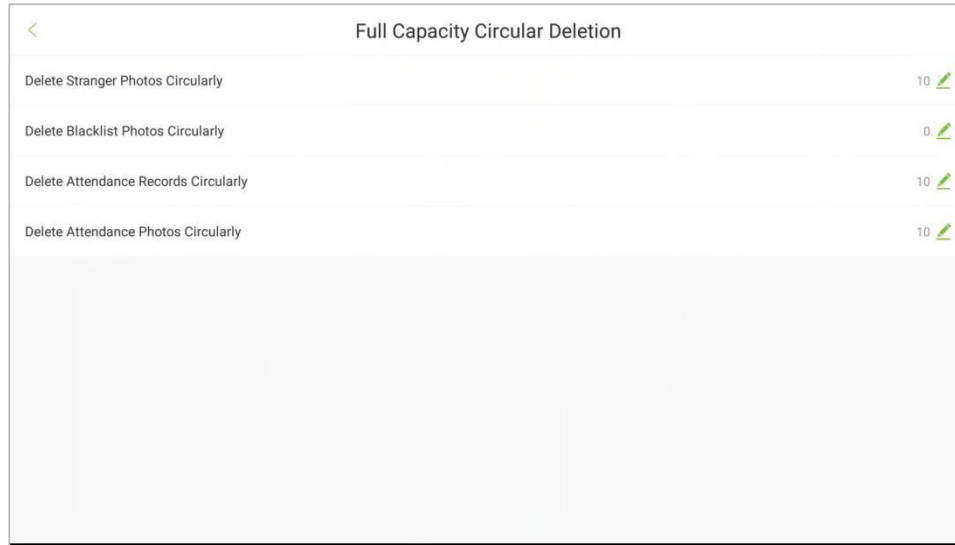

Delete Stranger Photos Circularly: When the Stranger's photo reaches the maximum capacity, the device will delete the earliest strangers' photos in a cycle. The range is 0-999. 0 means the photos will not be deleted.

Delete Blacklist Photos Circularly: When the blacklist user's photo reaches the maximum capacity, the device will delete the earliest photos in a cycle. The range is 0-999. 0 means the photos will not be deleted.

Delete Attendance Record Circularly: It indicates the duration as far as the attendance records will be saved. That means, when the attendance record reaches the maximum capacity, the system deletes the earliest records in a cycle. The maximum capacity of attendance record is 100,000. The range is 0-9999. 0 indicates that the records will not be deleted.

Delete Attendance Photo Circularly: When attendance photo reaches the maximum capacity, the device deletes the earliest attendance photo in the cycle. The maximum capacity of the attendance photo is 10,000. The range value is 0-9999. 0 indicates that the records will not be deleted.

5.7 Stranger Recognition

Open **System Setting** → **Stranger Recognition**.

When this feature is enabled, the stranger's face appearing on the screen will be recognized and captured as an unregistered person. The captured photos can be viewed in **Record Search**. When this feature is disabled, the stranger's face will not be recognized.

5.8 Stranger Alarm

Open **System Setting** → **Stranger Alarm**.

When this feature is enabled, the alarm will ring for 10 seconds if the stranger's face appears on the monitoring screen. Tap on  in the home screen to turn off the alarm temporarily, as shown below:

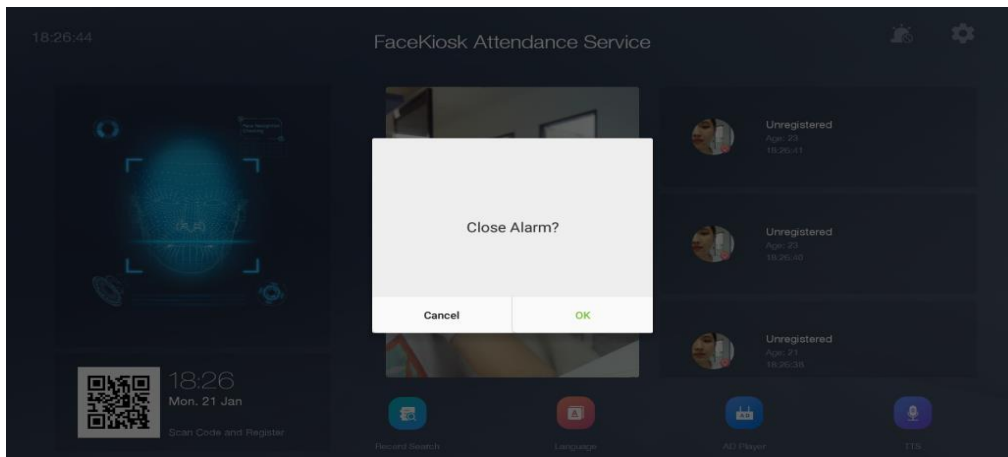

5.9 Save Blacklist Photos

Open **System Setting** → **Save Backlist Photos**.

This feature helps to capture the photo of the person in the blacklist when he/she appears on the monitoring screen. The captured photo records can be viewed in **Record Search**.

5.10 Blacklist Alarm

Open **System Setting** → **Blacklist Alarm**.

When it is enabled, the alarm will ring for 10 seconds if the person in blacklist appears on the monitoring screen.

Tap on  in the home screen to turn off the alarm temporarily, as shown below:

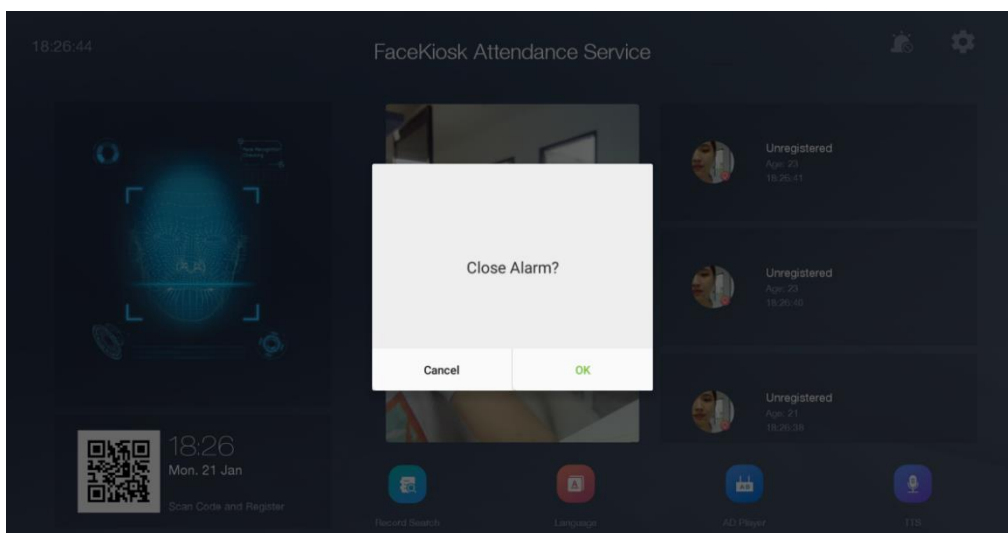

5.11 Barcode Scanner

Open **System Setting** → **Barcode Scanner**.



Tap on  to set the **Display Time** of the barcode. The range is from 3 to 20(unit: second). The default display time is 3 seconds which means that when a barcode scanner reads a valid QR code, the content will be displayed on the screen for 3 seconds.

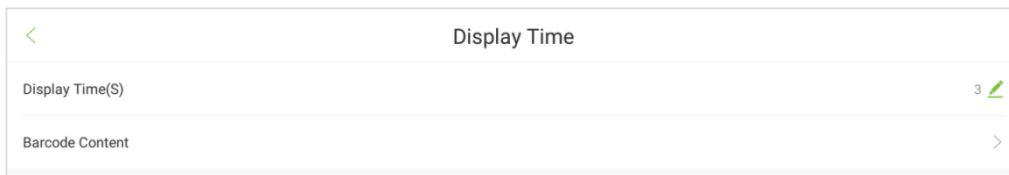

Tap on **Barcode Content** to set the parameters of Barcode content.

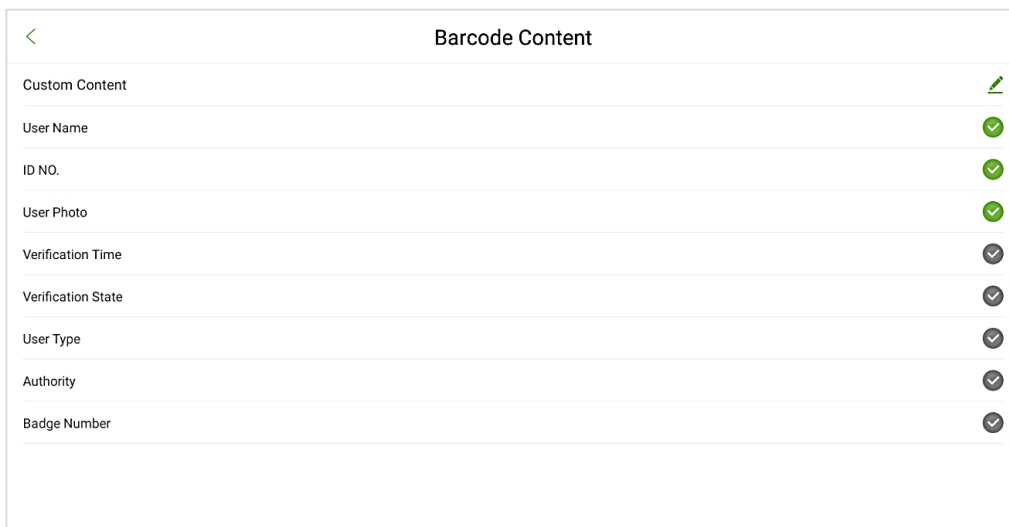

5.12 QR Code Setting

Open **System Setting** → **QR Code Setting**.

The users can set the URL address in two ways:

Synchronize from Cloud Server

When you choose to synchronize from the Cloud Server, the QR code address will be fetched from the background Server. After setting the Server, use your phone to scan the QR code on the home screen. The Employee registration screen will be displayed on the phone. The QR code displayed on the device will automatically obtain the device's serial number information. When the user scans the QR code to register, the device's serial number will be seen in the **Review** menu on the software.

The format of the QR Code address is:

ZKBiosecurity3.0 Software QR code Address setting: http://server IP: port/app/v1/adreg

BioTime8.0 Software QR code address setting: http://server IP:port /v1Register

Custom Address

While choosing a custom address mode, the user can enter a valid URL address as the QR code address. E.g.: <http://www.zkteco.com/en>

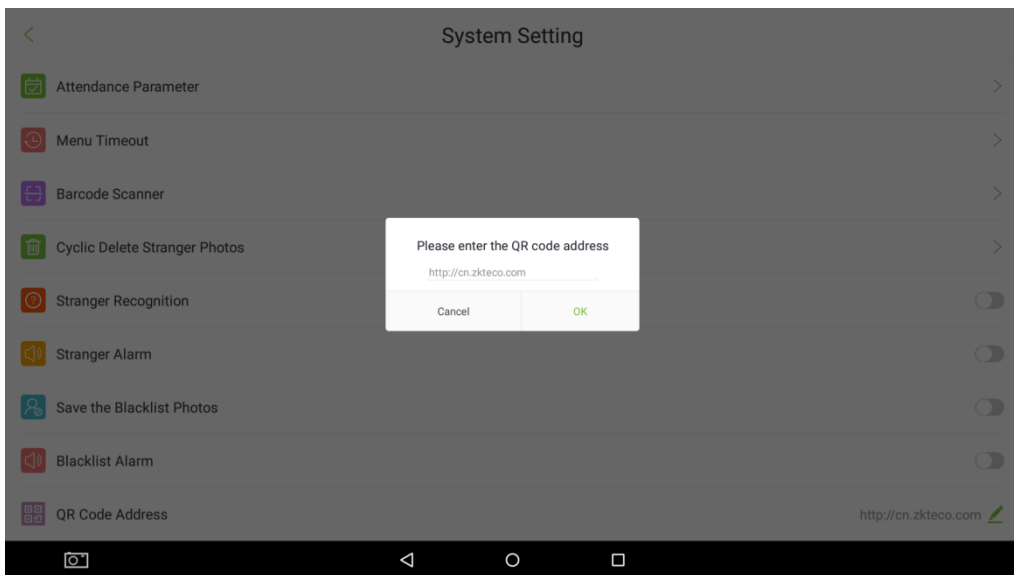
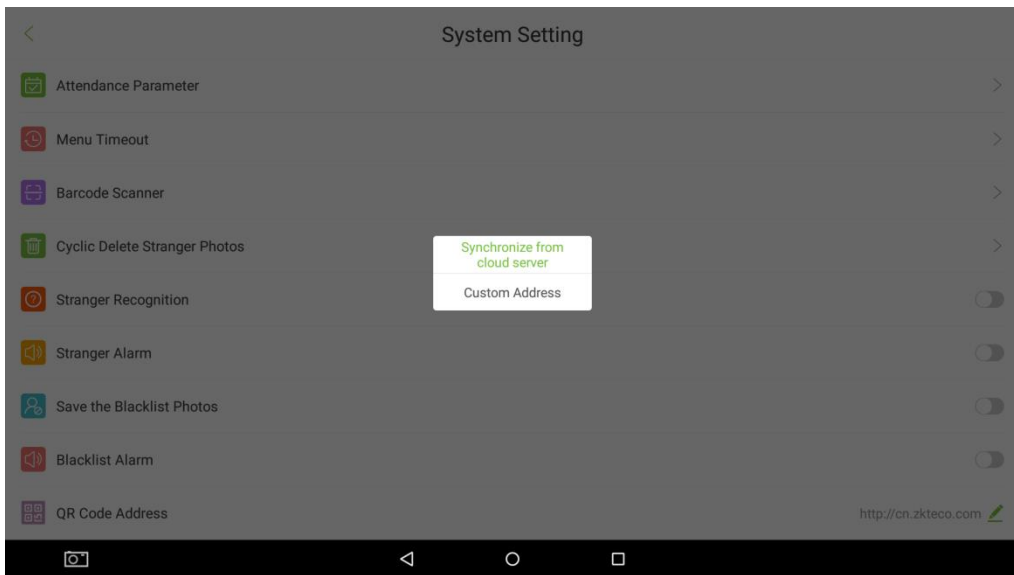

6 Data Management

Tap on **Data Management** on the main menu to perform data management operations such as Deletion, Restoration, and Data backup.

6.1 Clear Data

Open **Data Management** → **Clear Data** to delete the data.

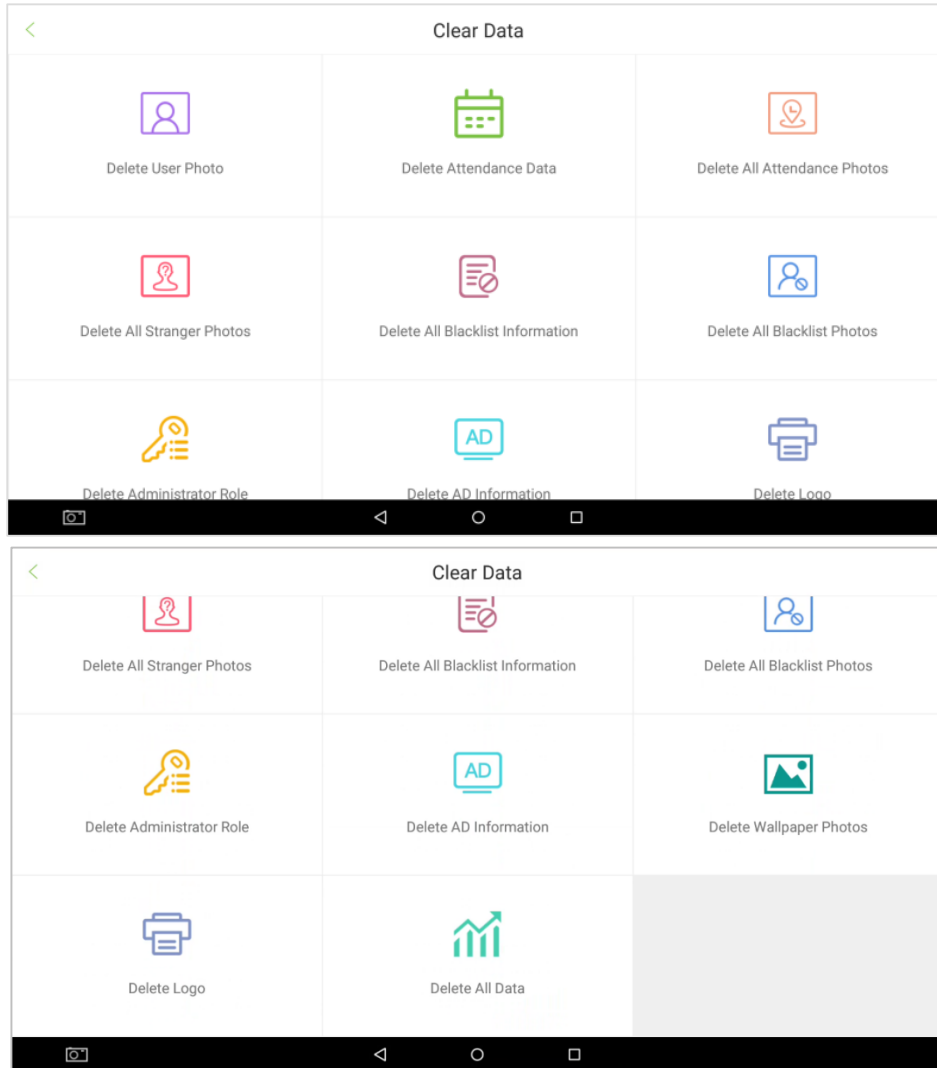

Description of fields:

Delete Attendance Data: Deletes all the attendance records in the device, or data in a specific time period.

Delete User Photo: Deletes all the user's photos from the device.

Delete Advertisement Information: Deletes all or some specific advertisement pictures from the device.

Delete all Attendance Photos: Deletes all the attendance photos from the device.

Delete all Blacklist information: Deletes all the blacklisted records from the device.

Delete all blacklist photos: Deletes all the blacklisted photos from the device.

Delete all stranger photos: Deletes all the stranger’s photos from the device.

Delete Administrator role: Deletes the authority of a specific administrator from the device.

Delete logo: Deletes the selected logo pictures from the device.

Delete wallpaper photos: Deletes the selected wallpaper pictures from the device.

Delete all data: Deletes all the data from the device.

6.2 Backup Data

Open **Data Management** → **Backup & Restore** → **Data Backup**.

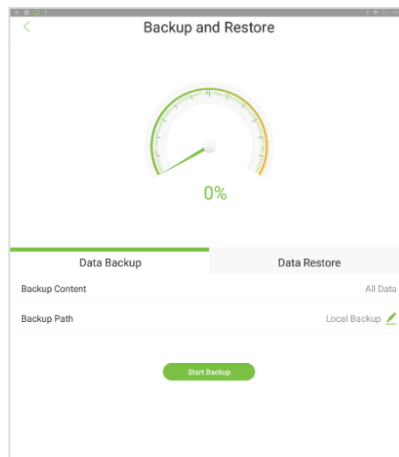

Menu	Function
Backup content	Backs-up all the data by default.
Backup path	Set the path as Local backup/U-disk backup . Local backup: Backup the data to the specific path of the device by default. U-disk backup: Backup the data to the USB disk inserted to the device.
<p>After setting the details, tap on Start backup to back up the content to the specific path of the device or the U-disk.</p>	

6.3 Restore Data

Open **Data Management** → **Backup & Restore** → **Data Restore**.

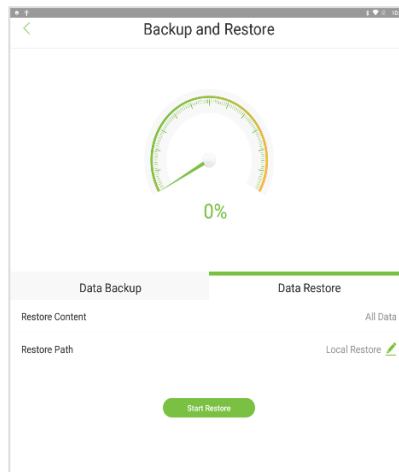

Menu	Function
Restore content	Restores all the data by default, cannot be modified.
Restore path	Set the path as Local backup/U-disk backup . Local backup: Backup the data to the specific path of the device by default. U-disk backup: Backup the data to the USB disk inserted to the device.
After setting the details, tap on Start restore to restore the data in the device or U-disk.	

7 USB Management

Tap on **USB Management** on the main menu. Insert a USB drive into the USB port of the device before uploading/downloading the data.

7.1 Uploading Data from the USB drive

Select **U-disk Management** → **USB upload**. The interface to upload the data from the USB drive will be displayed as shown below:

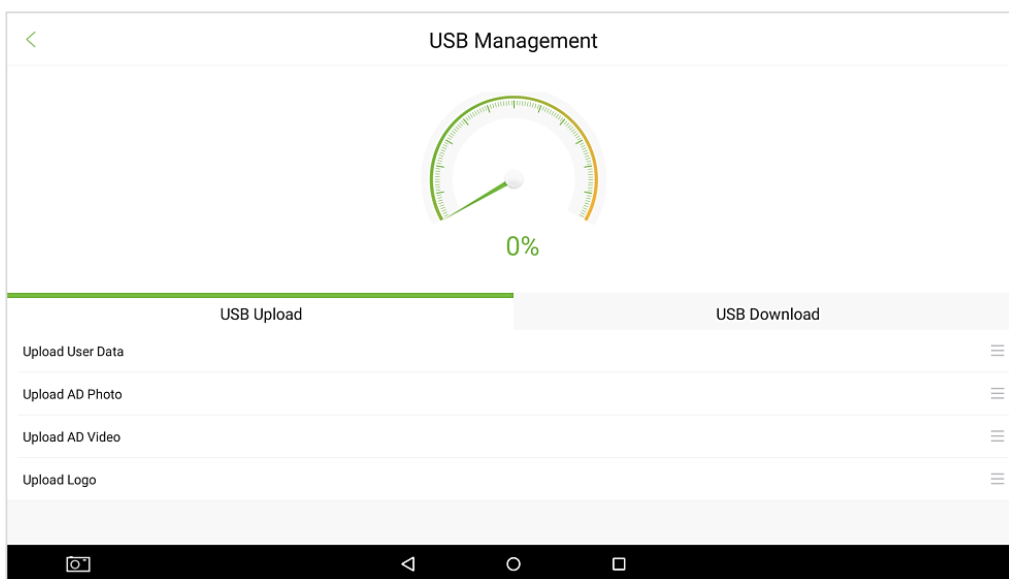

Menu	Function
Upload User data	Uploads the user information from the USB drive to the device.
Upload AD Photo	Create a folder in the root directory of the USB drive named "ad". Then, create a new folder named "picture" inside the folder "ad" to save the pictures for advertisements. The supported picture formats are JPG, BMP, GIF, and PNG.
Upload AD Video	Create a folder named "video" inside the folder "ad" to save the video advertisements. The supported file formats are AVI, 3GP, WMV, FLV, MP4, MKV.
Upload Logo	Create a folder named "logo" to save the logos to be printed. The supported file formats are JPG, BMP, and PNG. The recommended file type is BMP with 1-bit depth.

<p>Upload Wallpaper</p>	<p>Create a folder named “wallpaper” to save the photos. The supported file formats are JPG, BMP, and PNG. The recommended wallpaper size is 1920*1080.</p>
<p> You can only select either advertising pictures or advertising videos at a time.</p>	

7.2 Downloading Data to the USB drive

On the USB drive management screen, click on [USB Download]. You can import data from the device to other devices over the USB drive for spare use.

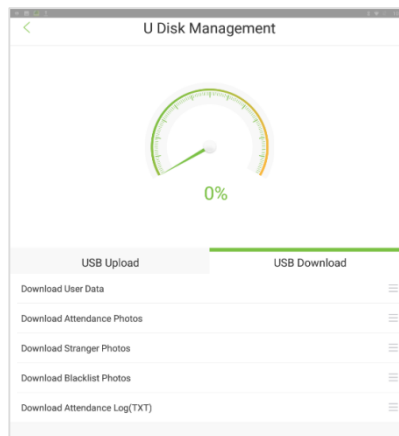

Menu	Function
<p>Download User Data</p>	<p>Downloads user information from the device to the USB drive.</p>
<p>Download Attendance Photo</p>	<p>Downloads all the attendance photos from the device or photos in a specific time period.</p>
<p>Download Stranger’s Photo</p>	<p>Downloads all the strangers’ photos from the device or photos in a specific time period.</p>
<p>Download Blacklist Photo</p>	<p>Downloads all the blacklisted photos from the device or photos in a specific time period.</p>
<p>Download Attendance Record (TXT)</p>	<p>Downloads all the attendance records from the device or records in a specific time period. The downloaded file format will be txt.</p>

8 Record Search

Tap on **Record Search** on the main menu to query the required records in the Face kiosk device.

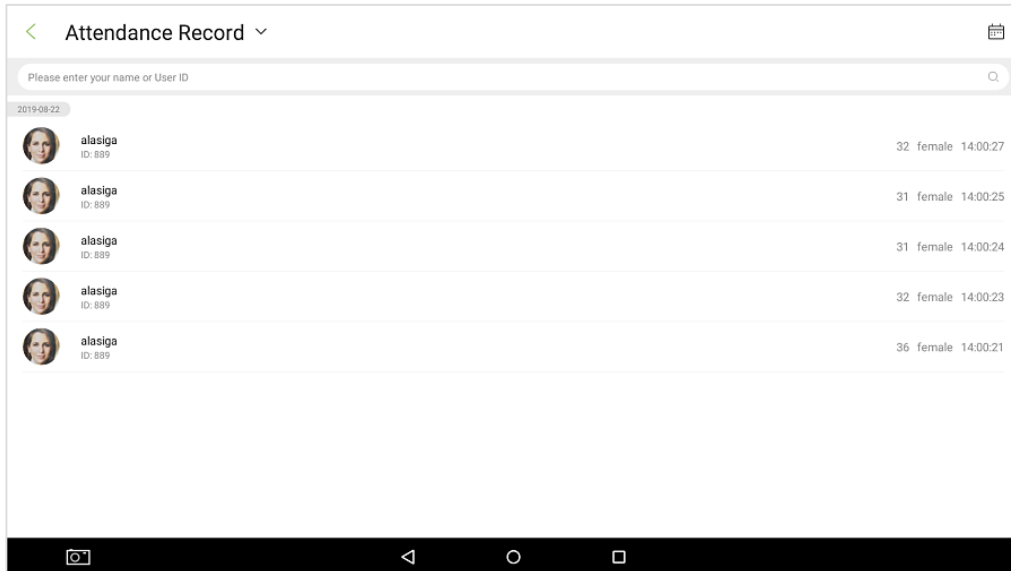

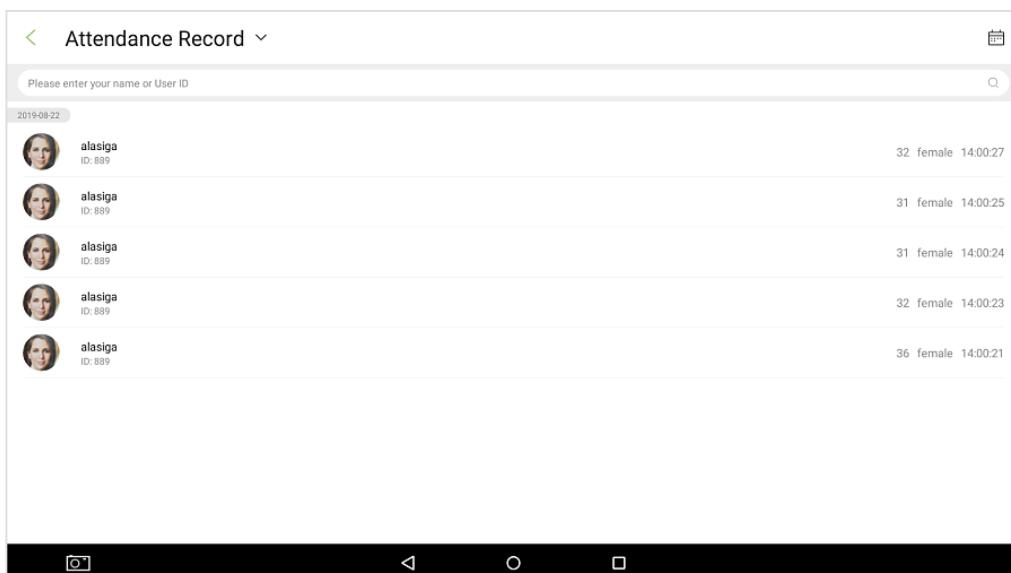

8.1 Attendance Records and Photos

Select **Record Search** → **Attendance record** to view all the attendance records in the device. Tap on  to filter the records accordingly as shown below:

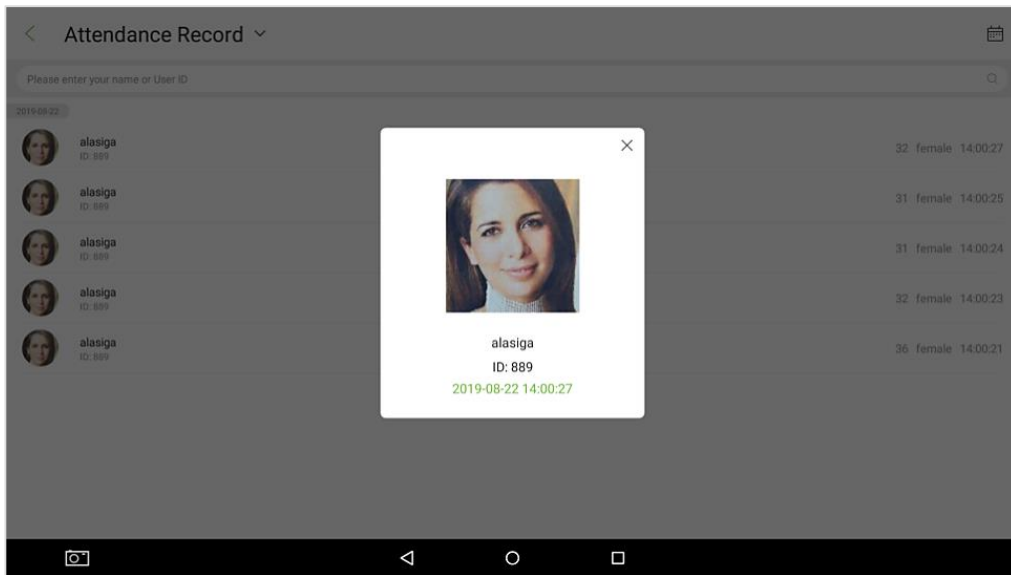

Tap on the picture of the person in attendance record to enlarge the photo. The details such as Employee Name, Employee ID, Check-in time, Attendance photo will be displayed as shown below:



 If the **Save Attendance photo** function is disabled, then the registered photo will be displayed. Go to **System setting** → **Attendance parameter** to enable this function.

8.2 Stranger's Photo

Select **Record Search** → **Stranger Photo** to view or delete the captured strangers' photo. Go to **System setting** → Enable **Stranger Recognition** to set this function.

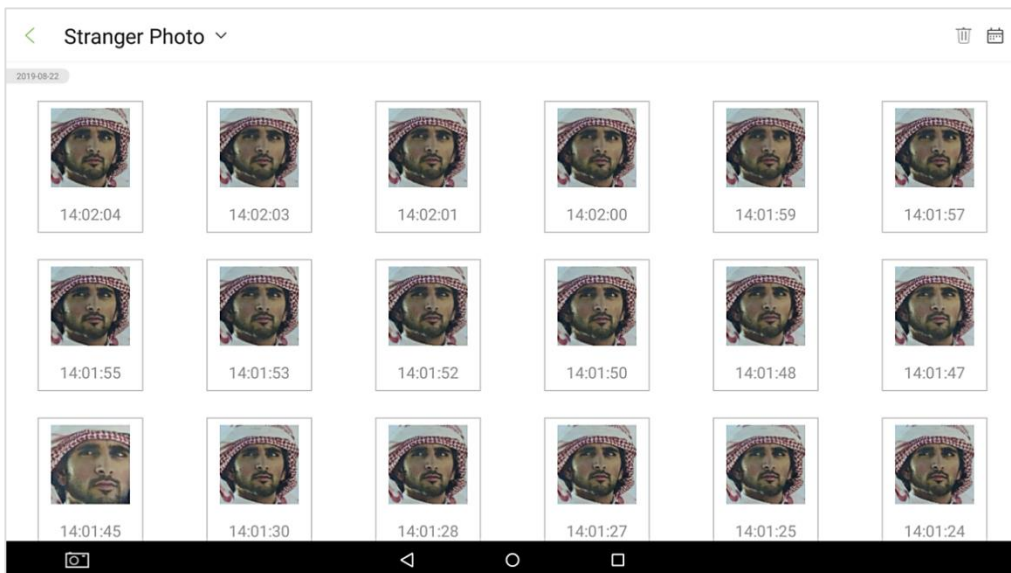

8.3 Blacklist Photo

Select **Record Search** → **Blacklist Photo** to view or delete the captured photos of the blacklisted persons. Go to **System setting** → **Save Backlist Photo** to enable this function.

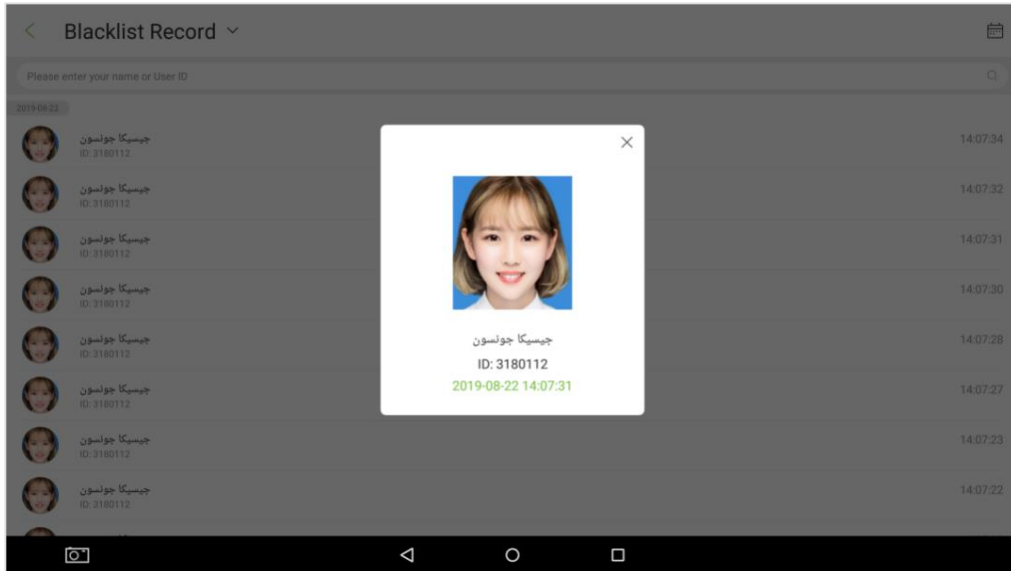

9 Print Management

Open **Print Management** → **Turn on Printing Function** to enable ticket printing feature and to view the related settings as shown in the below image:

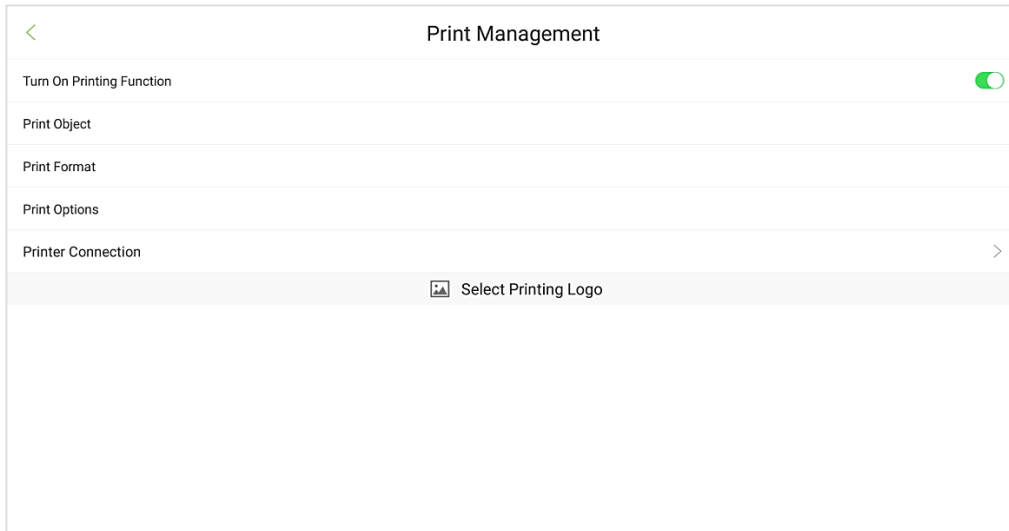

9.1 Print Objects

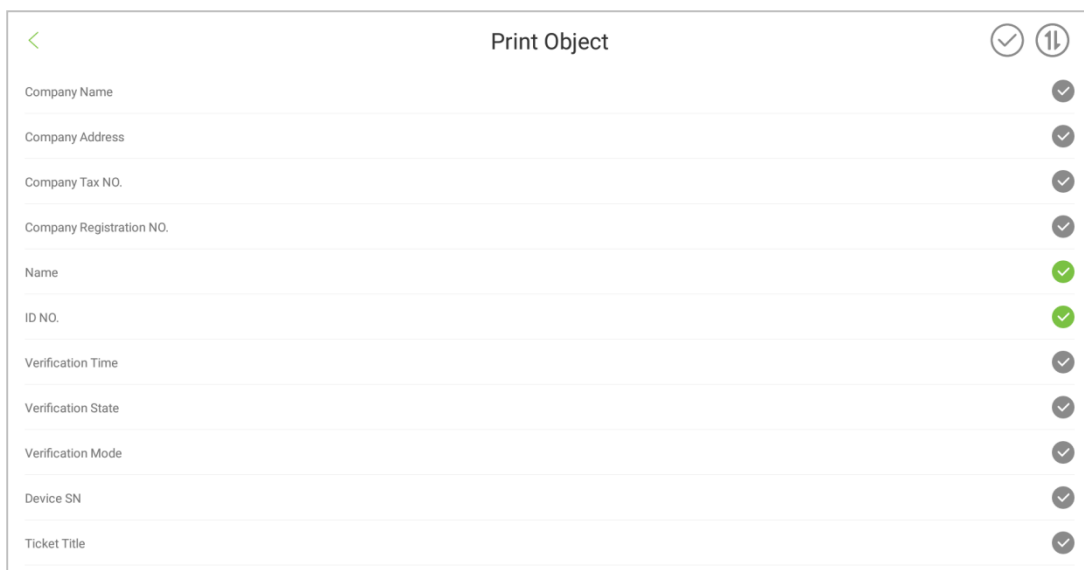

Open **Print Management** → **Print Object** to open the Successful verification interface. You can click the required fields to select the fields to be printed. The editable fields are, **Company Name, Company Address, Company Tax NO., Company Registration NO., Ticket Title, Dept Name**. The other fields will automatically fetch the data from the device.

You need to type and save the content of the above fields. Otherwise, you will not be able to use them. A maximum of 50 characters can be entered for a field.

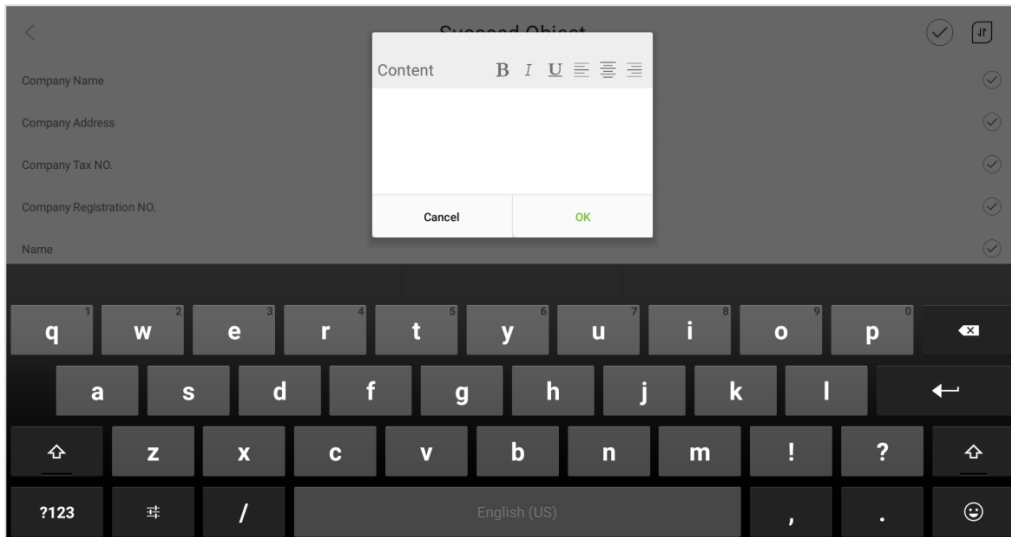

The device supports font styles such as Bold, Italic and Underline. You can also align the content to Left/Center/Right.



- Tap on  on the top right corner to view the selected fields.
- Tap on  to add a separator, hold and drag the separator to delete.
- Tap on  on the right side of the field and drag it up or down to sort the fields.

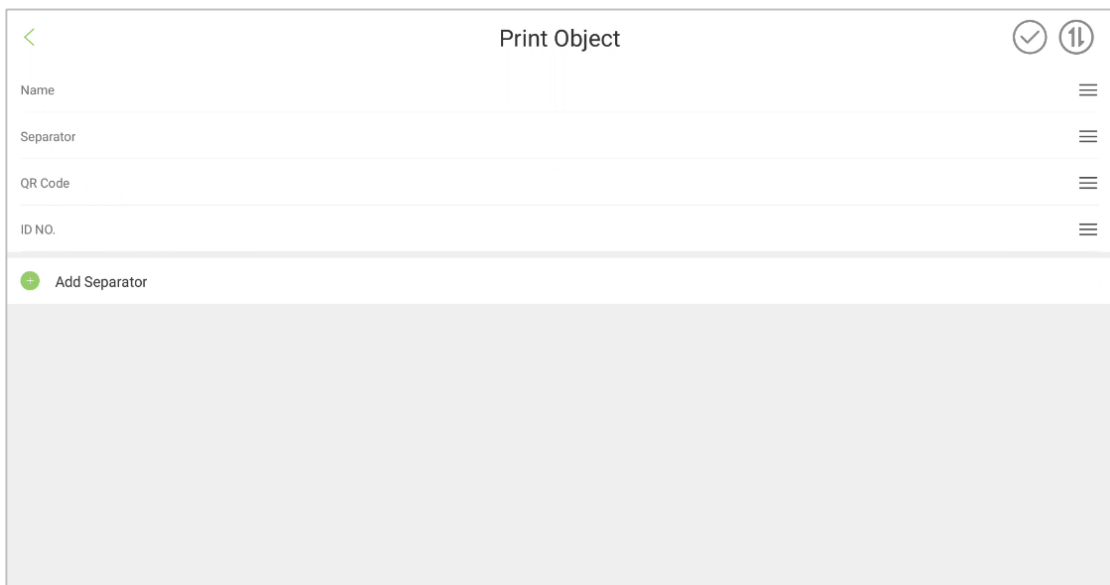

9.2 Print Format

Open **Print Management** → **Print Format** to set the printing specifications.

Print Format	
Separator Content	* ▼
Line Spacing	1.0 ▼
Font Size	24 ▼
Time Format	hh:mm a ▼
Date Format	MM/dd/yy ▼
QR Code Size	8 ▼
QR Code Position	Center ▼
Density Setting	200 

Menu	Function
Separator Content	The separator content supports '*', '-', and '#'. The default content is '*'.
Line Spacing	The line spacing options for printing are 0.5, 1.0, 1.5, 2.0. The default value is 0.5.
Font Size	The supported font size range is 18-30. The default font size is 24.
Time Format	Time format can be set to the printable.
Date Format	Date format can be set to the printable.
QR Code Size	The supported QR code size is 5-8. The default size is 8.
QR Code Position	The position of the QR code can be set to Align left, Center, Align right. The default position is the Center.
Density Setting	Density can be set to the printable. The value range is 70-200. The default value is 150.

9.3 Print Options

Open **Print Management** → **Print Options**.

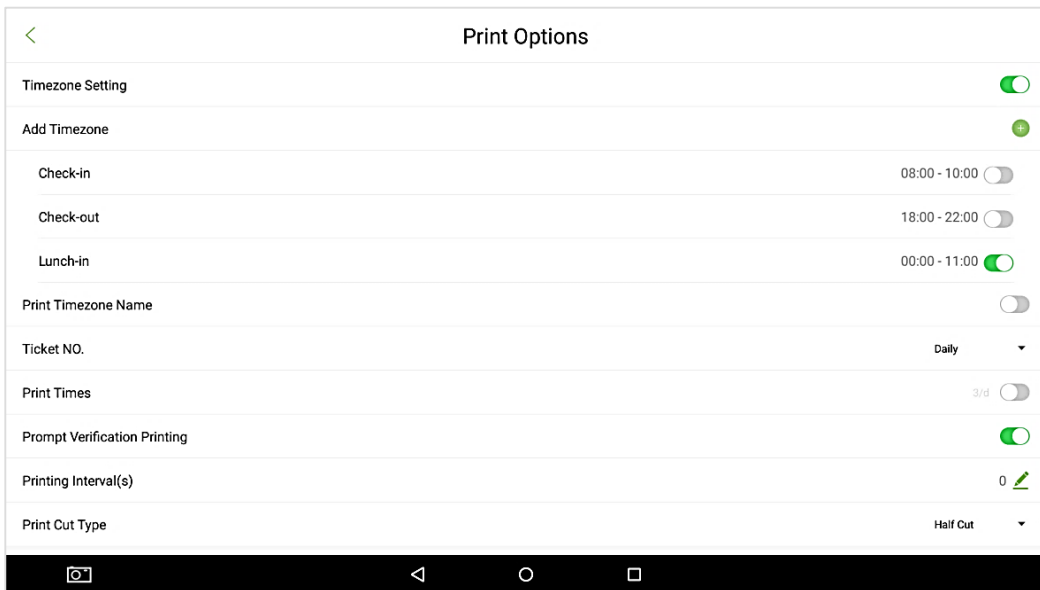

Menu	Function
<p>Time zone Setting</p>	<p>Enable the Timezone Setting to view the related menu. The users can only print the tickets within the timezone. There are two default timezones: Check-in and Check-out. The users can reset the time and name of these two default timezones.</p> <p>When you enable the Print Timezone Name function, the timezone name will be printed at the bottom of the ticket.</p>
<p>Ticket NO.</p>	<p>The ticket number starts from 1. The ticket number can be reset by day, week, month, a year or never reset.</p> <p>When set to Daily, the reset time will be 00:00:00 every day.</p> <p>When set to Weekly, the reset time will be 00:00:00 on every Sunday.</p> <p>When set to Monthly, the reset time will be 00:00:00 on the first day of the month.</p> <p>When set to Yearly, the reset time will be 00:00:00 on 1st January of every year.</p> <p>When set to Never reset, the ticket number continues.</p>
<p>Print Times</p>	<p>When you enable Print times, every user can only print the tickets for the specified number of times per day. The default value is 3.</p>
<p>Prompt Verification Printing</p>	<p>When you enable Prompt verification printing, the device will prompt the user to confirm printing after every verification.</p>

Printing Interval	When enabled, the device will limit the time that the device will no longer print after user verification. The limit time can be set 0-3600s. The default time is 0s.
Print Cut Type	The default print cut type is half cut. It also supports Total cut.

10 System Information

The **System Info** menu allows you to view the device storage and version information.

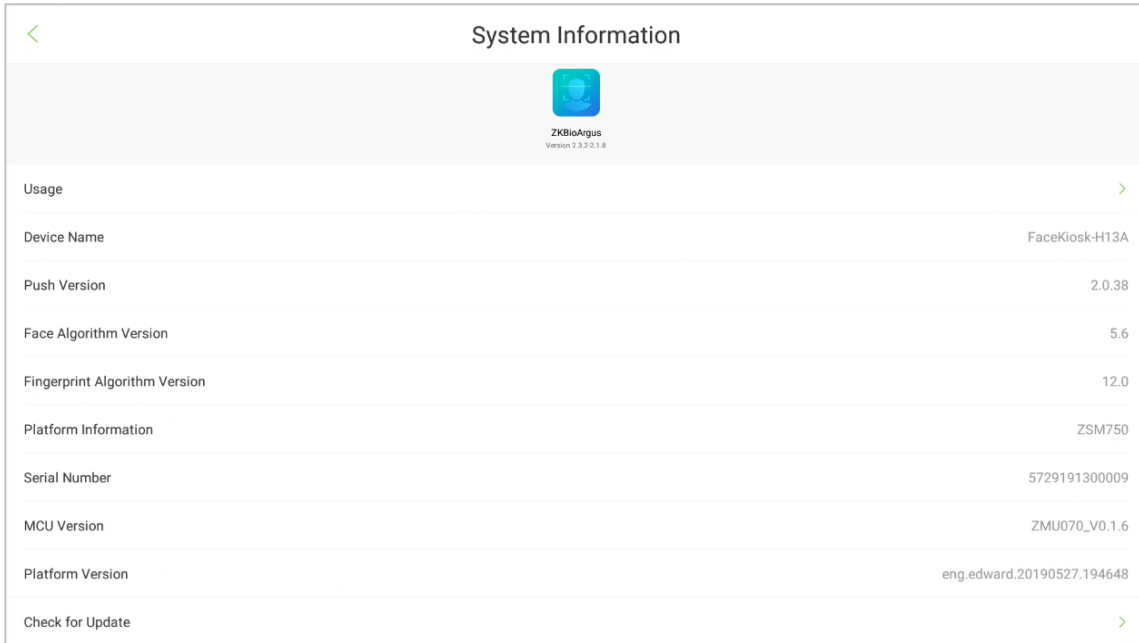

Usage: The storage information includes User capacity, Admin capacity, Attendance Record capacity, Stranger Photo capacity, Blacklisted Photo capacity, and Attendance Photo capacity.

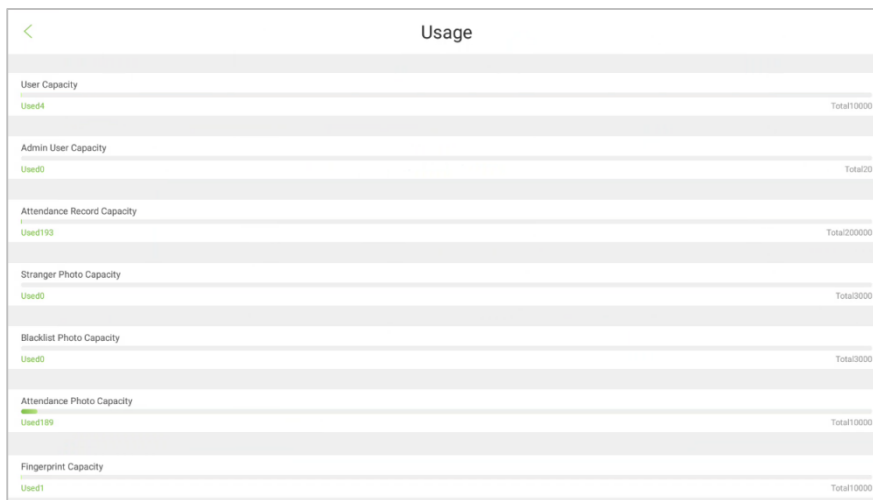

The device information includes Device Name, Firmware version, Push version, Face Algorithm version, Fingerprint Algorithm version, Serial Number, MCU version, Platform version of the device.

Check for Update: The device support online update for firmware. Click here to check if there is new firmware version for updating. The device is required to be in WAN environment.

11 Advertisement Setting

Open **AD Setting** → **Turn on AD Player** to turn on the Ad player. When it is tuned on, you can set the advertisement photo/video switching time, Ad switching time if the face is not detected, Timed advertising period as shown in the below image:

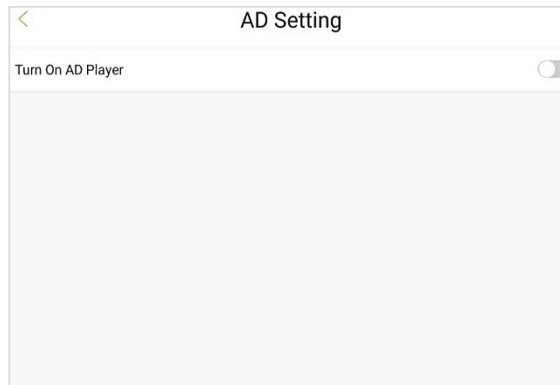

1. Turn on the Advertisement player.

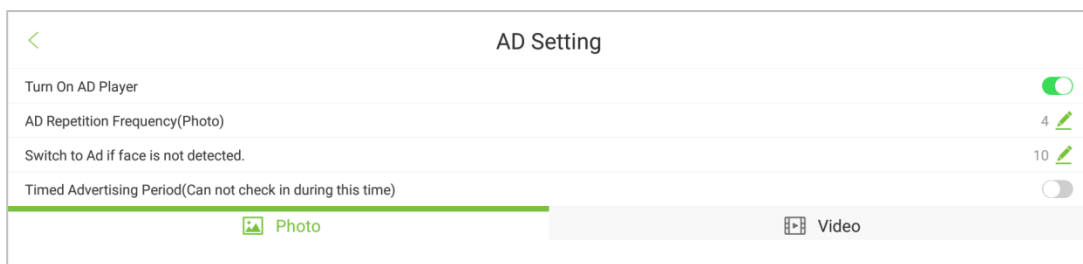

2. Select Photo/Video.

Note: Select either advertising photo or video.

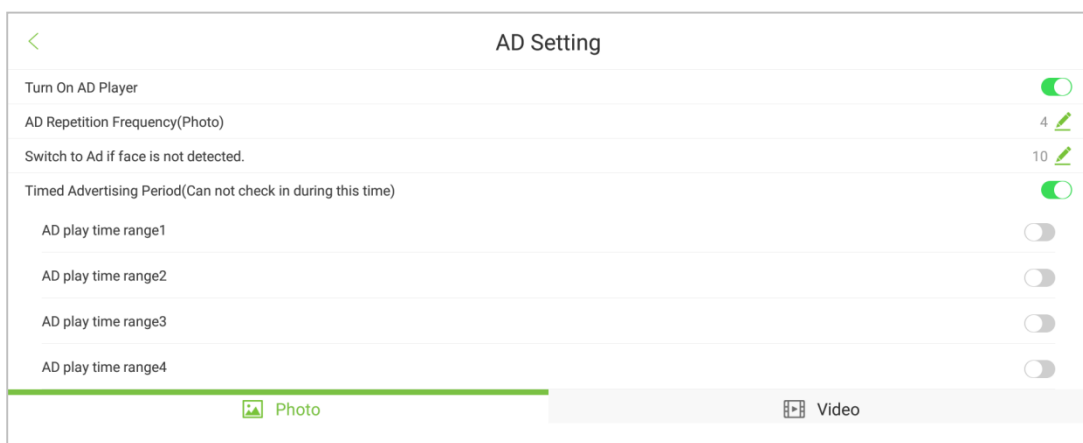

3. Set the Picture/Video playing time (unit: s).

Description of fields:

Ad reception frequency: Sets the repetition frequency of the Advertisements.

Switch to Ad if face is not detected: Sets the time duration after which, the advertisement picture/video will be displayed if a face is not detected.

Manual Sliding of advertisement: Slide the advertisement to the left side directly from the right side of the face monitoring interface.

The illustration is shown below:



Advertisement Playing Time: Set the time period for the advertisement. If the advertisement time period overlaps with the check-in/check-out time range or the check-in/check-out time of the meeting, the device switches to the face check-in interface when someone's face is detected in the monitoring area and then switch back to the advertisement interface when there is no check-in.

12 Personality Setting

Tap on **Personality Setting** on the main menu. You can set the Voice Broadcast Content, Sleep time of the device, Status bar display, Special effects for VIP, etc. as shown below:

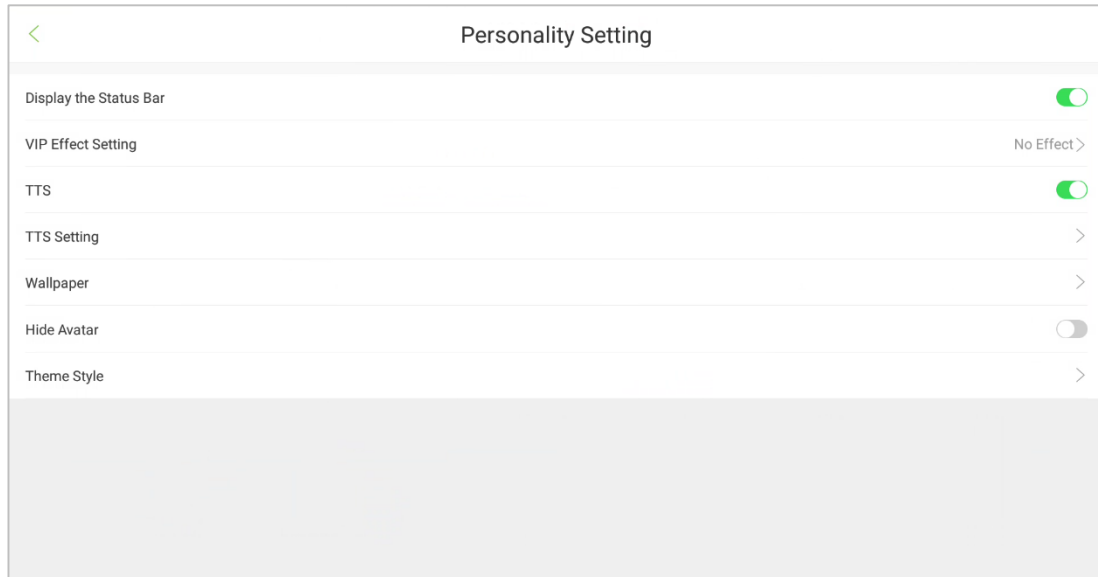

Description of fields:

Display Status bar: Displays or hides the status bar of the device.

VIP S Effect Setting: Sets the special effects for VIP. You can choose from the four available special effects. The default setting is **No effect**.

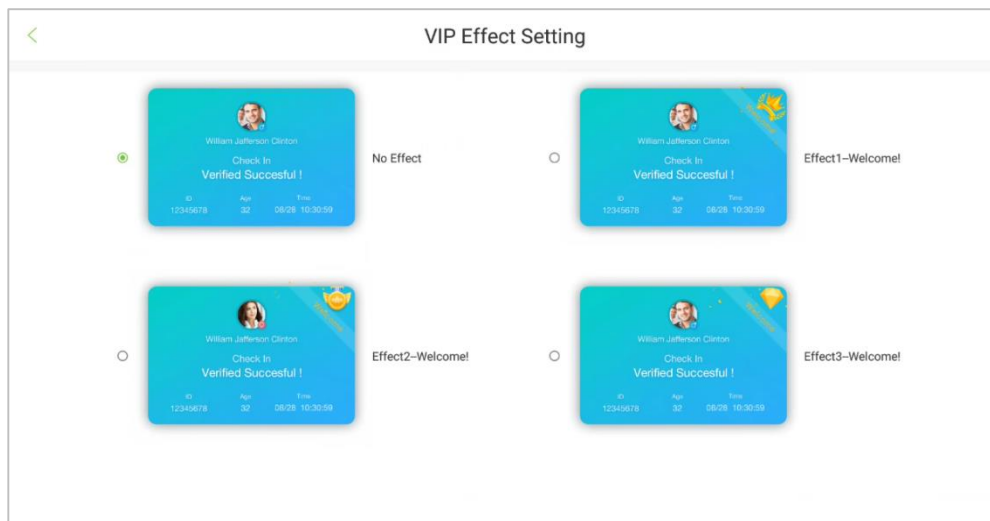

TTS (Voice Broadcast): Turns on the voice broadcast function.

TTS Setting: Sets the voice broadcast content, as shown below:

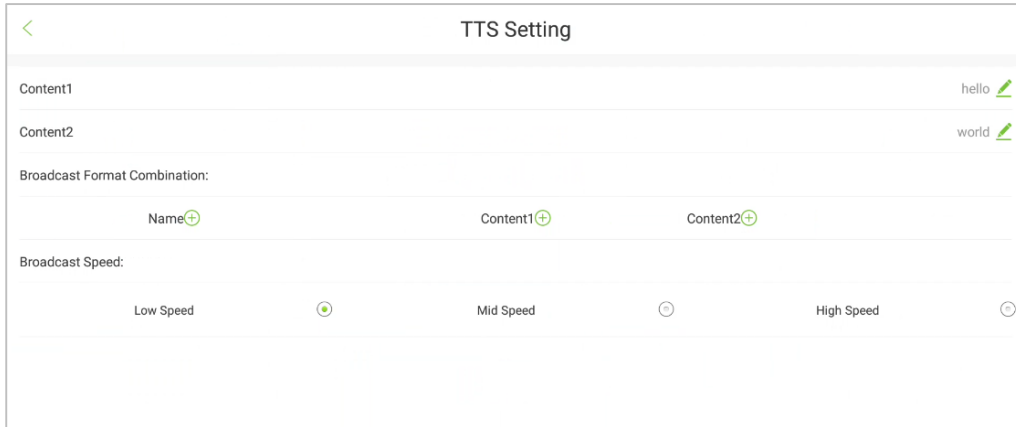

Menu	Function
Custom content 1	Supports Letters, Numbers and Chinese characters. A maximum of five characters can be entered.
Custom content 2	Support Letters, Numbers and Chinese characters. A maximum of five characters can be entered.
Broadcast Format Combination	Sets the voice broadcast content format. The default is to broadcast the Name only.
Voice Broadcast Speed	Sets the broadcasting speed. It can be Low/Medium/High

Note: Setting up more characters leads to the longer broadcasting time. In multiple recognition scenarios, this influences the result of successful recognition. You can choose to enable this function or not according to your actual needs.

Wallpaper: Sets the wallpaper of main interface base on the selected theme. You can upload wallpaper photos in [USB Management](#)

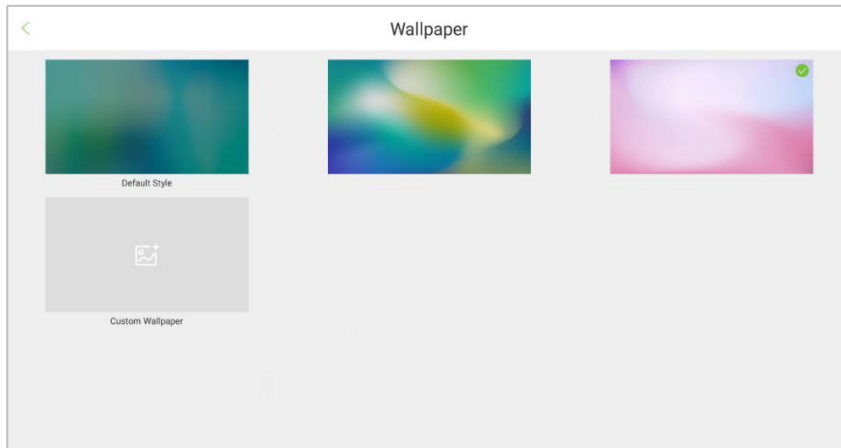

Theme Style: Sets the theme of main interface. Facekiosk-H13 support 3 themes shown as below

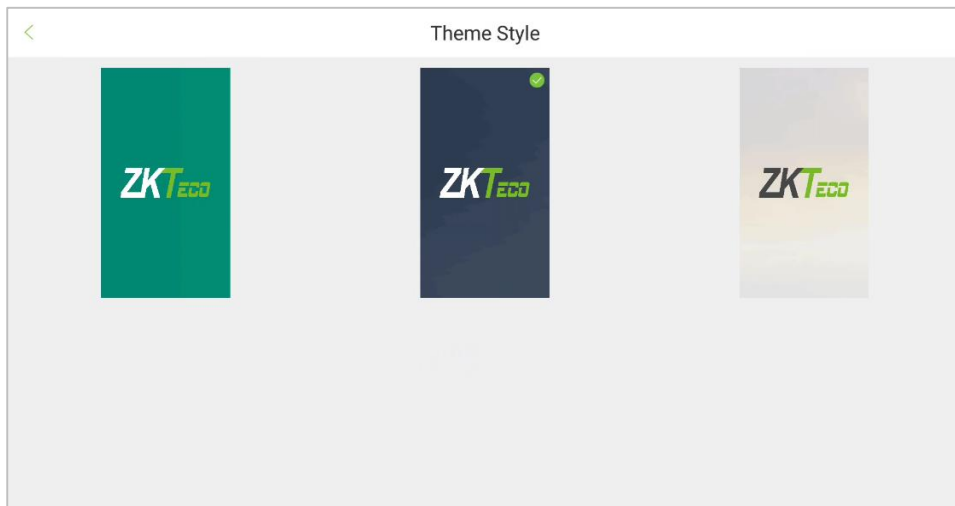

Hide Avatar: Turn on the function the user avatar will not be displayed in main interface after verification.

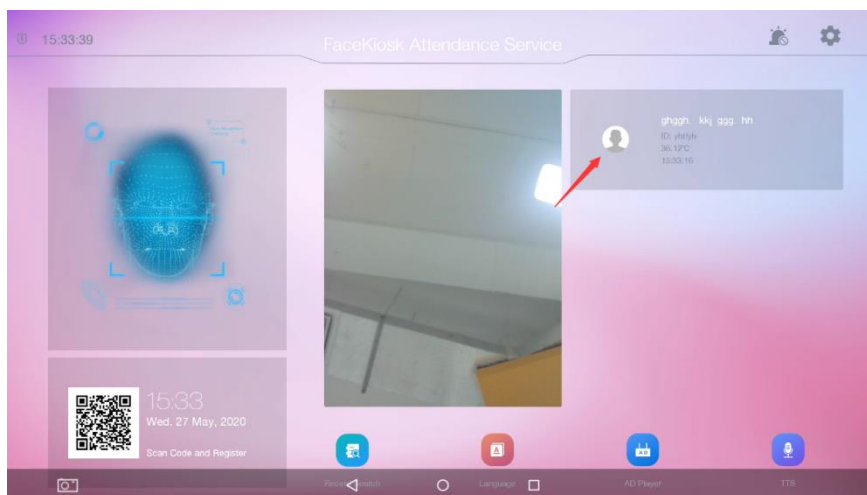

13 Access Control Management

Tap on **Access Control Management** in the main menu. The related parameters of access control can be set here as shown below:

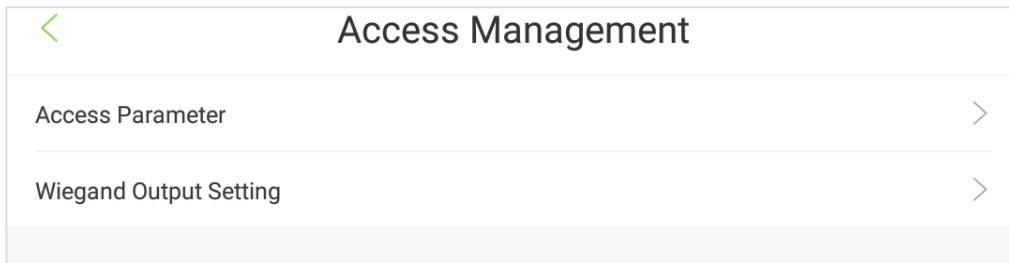

13.1 Access Control Parameters

Open **Access Management** → **Access Control Parameter** to set the access control parameters as shown below:

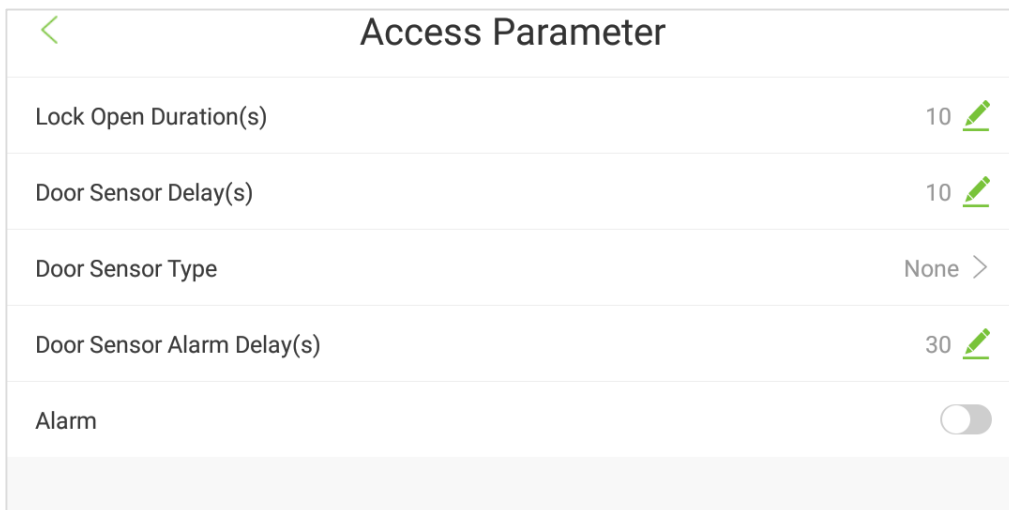

Description of fields:

Door Lock Delay (s): The time duration for which the lock will be kept unlocked by the device. (Range: 1 to 10 seconds).

Door Sensor Delay (s): When the door is opened, the state of the door sensor will be monitored. If the state of the door sensor is inconsistent with that of the door sensor mode, the alarm will be triggered. (Range: 1 to 99 seconds).

Door Sensor Type: There are three types: No, Normally Open, and Normally Closed.

No means the door sensor is not currently used.

Normally Open means the door remains open always when powered on.

Normally Closed means the door remains closed when powered on.

Door Alarm Delay (s): When the state of the door sensor is inconsistent with that of the door sensor type, an alarm will be triggered after a time period. (Range: 1 to 99 seconds).

Alarm: Enable to turn on the alarm feature in case of any security breaches.

13.2 Wiegand Output Setting

Select **Access Management** → **Wiegand Output Setting** to set the related parameters, as shown below:

Wiegand Output Setting	
Output Type	User ID
Wiegand Output Bits	Wiegand34 >
Pulse Width(μs)	100
Pulse Interval(μs)	1000
Failed ID	Disable >
Site Code	Disable >

Description of fields:

Type: Displays User ID by default and it cannot be modified.

Wiegand Output Bits: The default is Wiegand34. Other types are Wiegand26, Wiegand26a, and Wiegand34a.

Pulse Width (μs): The default value is 100, the range is 20 to 400 μs.

Pulse Interval (μs): The default is 1000, the range is 200-20000 μs.

Failed ID: It is the output value for the failed user verification. The output format depends on the **Wiegand Format** setting. It's disabled by default; the range is 0 - 65535.

Site Code: Customizes the Wiegand format. It is almost similar to the device ID. The only difference is that it can be set manually and can be repeated for different devices. It's disabled by default; the range is 0 - 256.

14 BioTime 8.0 Connection

The device is designed to communicate with the Attendance module of **BioTime 8.0 Software**, to add the users through the software. In addition, you can also upload the attendance records to this software for further attendance calculation.

14.1 Adding a Device

You can add a device in two ways to the BioTime software.

Automatic Addition:

Set the Server IP address and the port number on the device to be added.

Manual Addition:

Perform the following steps to add a device manually:

1. Open the BioTime software. Then select **Device → Device → Add**.

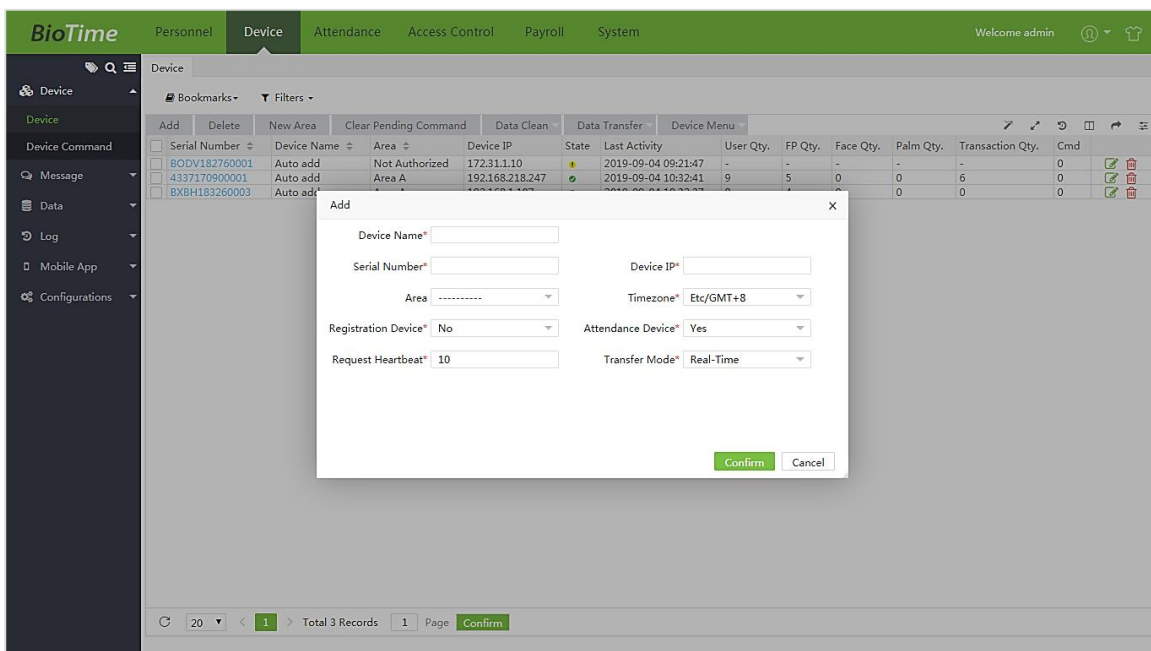

2. Set the following parameters:

Device Name: Enter the name of the Attendance device. You can enter up to 20 characters.

Serial Number: Enter the Serial Number of the Attendance device.

Device IP: Enter the IP Address of the device.

Area: Select the areas to be configured to the Attendance device.

Time Zone: Set the time zone for the device.

Registration Device: If this feature is set to "Yes", the device also acts as an employee registration device. If set to "No" only attendance data will be registered.

Request Heartbeat: Set the time to send the heartbeat request to the device. The unit is **second**.

Transfer Mode: If “Real time” is selected, the attendance data will be updated in the software simultaneously. If “Timing” is selected, the attendance data will be updated in the software at the specified time.

Enter all the required fields and select **Confirm**.

14.2 User Management

Open the BioTime software. Then select **Personnel** → **Employee** → **Employee** → **Add** to add a new user.

The screenshot shows the BioTime software interface with the 'Add' form for a new employee. The form is divided into several sections:

- Profile:** Employee ID*, Department*, Position, Employment Type, First Name, Last Name, Area*, Hired Date (2019-09-04), and a Photo upload area.
- Private Information:** SSN, Gender, Passport NO., Motorcycle License, Contact Tel, Mobile, National, City, Address, Email, Local Name, Automobile License, Office Tel, Religion, and Postcode.
- Device Access Setting, Attendance Setting, App Setting, Payroll Settings:** These sections are currently empty.

The interface also shows a sidebar with navigation options like Organization, Employee, Resign, Workflow, and Configurations. The top navigation bar includes Personnel, Device, Attendance, Access Control, Payroll, and System. The bottom of the form shows a pagination bar with 'Total 9 Records' and a 'Confirm' button.

Enter the basic details of the employee such as Employee ID, Name, Department, Position, Area, Type of employment, Hired date. Refer the User Manual for further details. Add other details such as Private Information, Device Access Setting, Attendance Setting, App Setting, Payroll Setting as per your requirements.

Instructions to upload the photo:

Make sure that the face is in the center. There must not be any deformation or reflection in the photo. The recommended pixel range is 640*480 to 1920*1080. Only JPG format is supported.

To capture a photo, perform the following steps:

1. Connect an external camera or open the built-in camera of the device.
2. Open the **Personnel** module. Then select **Personnel** sub-menu and click the **Employee ID** or the **Edit** icon. The interface to edit the employee details will be displayed.
3. Click **Capture**. The photo capturing screen will be displayed. The browser allows you to select the camera. The screen is as follows:

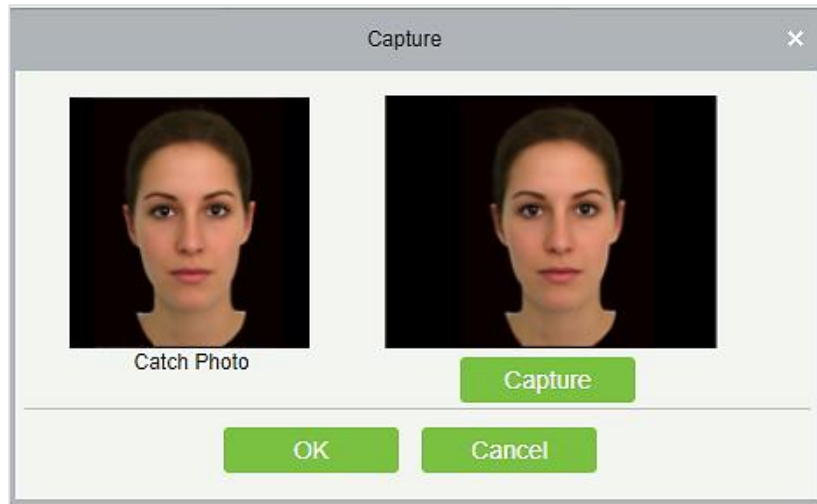

4. Click **Capture** to capture the photo, after capturing the photo, click **OK**.

14.3 Attendance Management

Once the attendance records are uploaded to the software, you can process the attendance statistics for further operation such as Payroll calculation. Click  on the home screen of the Kiosk to view the help menu. Also, refer to the User Manual of BioTime 8.0 for software related queries.

15 ZKBiosecurity Connection

The device is designed to communicate with the Attendance module of the **ZKBioSecurity Software**, to perform functions such as adding users and advertising pictures/videos. In addition, you can upload the attendance records to the software for further attendance calculation.

15.1 Adding a Device

You can add a device in two ways to the ZKBioSecurity software.

Perform the following steps:

1. Open the ZKBioSecurity software then select FaceKiosk → **Device** → Search **Device** → **Add**.

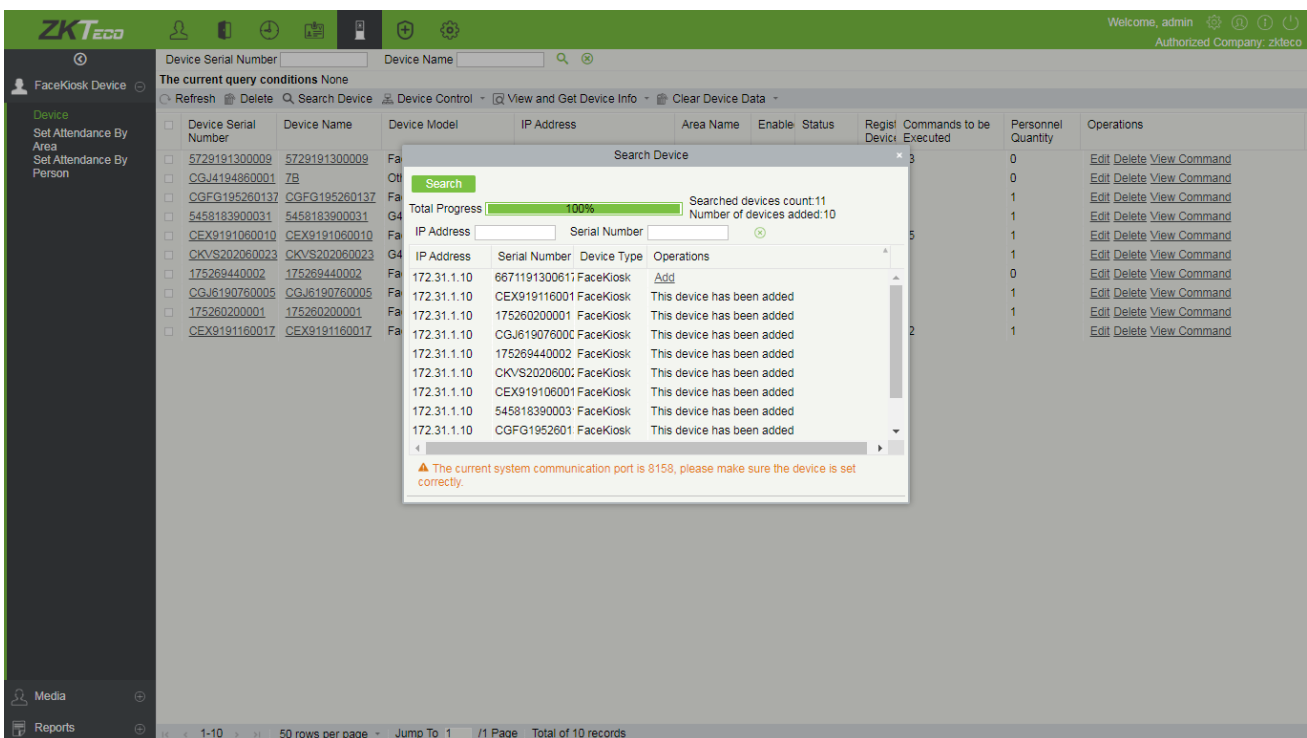

15.2 User Management

15.2.1 Adding a User

Open the **Personnel** module in the ZKBioSecurity software. Then select **Personnel** → **Person** → **Add** to add a new user.

Enter the basic details of the employee such as Employee ID, Name, Department, Position, Area, Type of employment, Hired date. Refer the User Manual for further details.

Click here to upload a [photo](#).

15.2.2 Importing User Data and Photo

Importing User Data

1. Click **Export** → **Export Personnel Template**, select the user information fields. Click **OK** to download the template.

2. Fill the data in the template.

3. Then click **Import** → **Import Personnel**. The interface will be displayed as shown below:

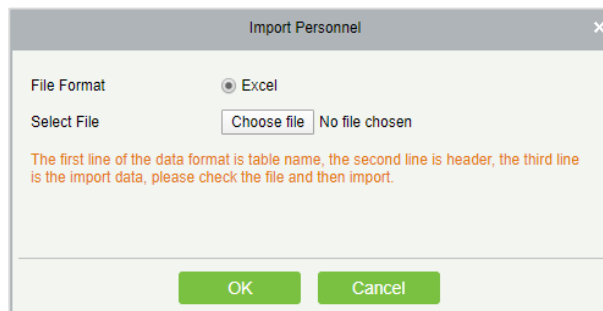

The parameters are described as follows:

File Format: The default format is Excel.

Select the file to be imported and click **OK**.

Importing user photo

Click **Import** → **Import User Photos** to import user photos to the software.

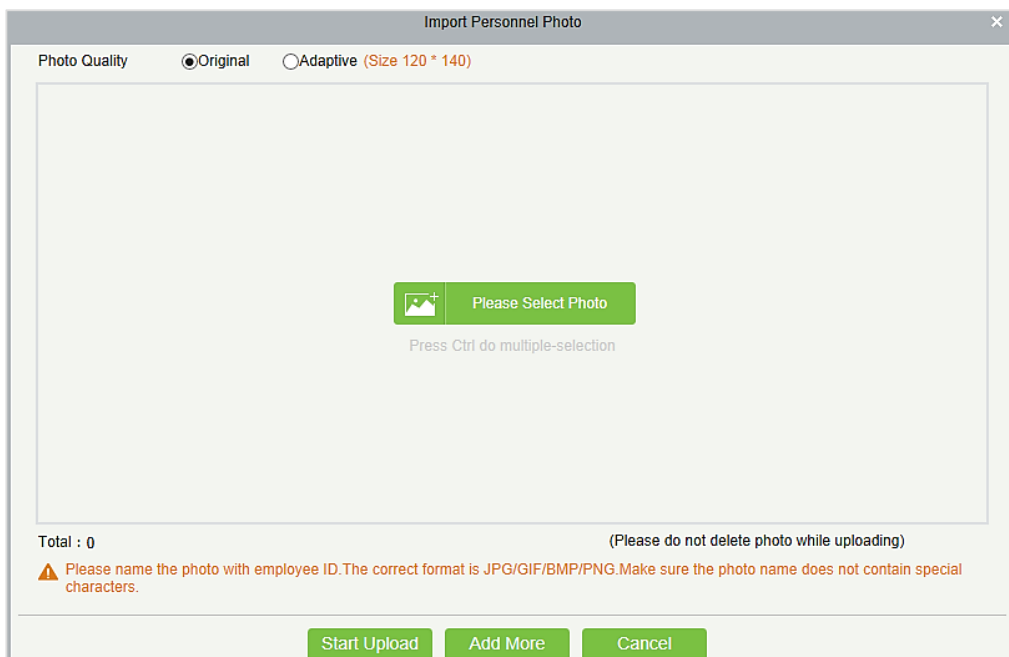

Note: Use the employee ID to name the photo. The supported format is JPG. The photo name must not contain special characters.

Click **Please Select Photo** and select the photo. You can select multiple photos by pressing the **Ctrl** key. Click **Start Upload** to import the photos.

15.3 Adding Advertisement

You can either add pictures or videos as an advertisement.

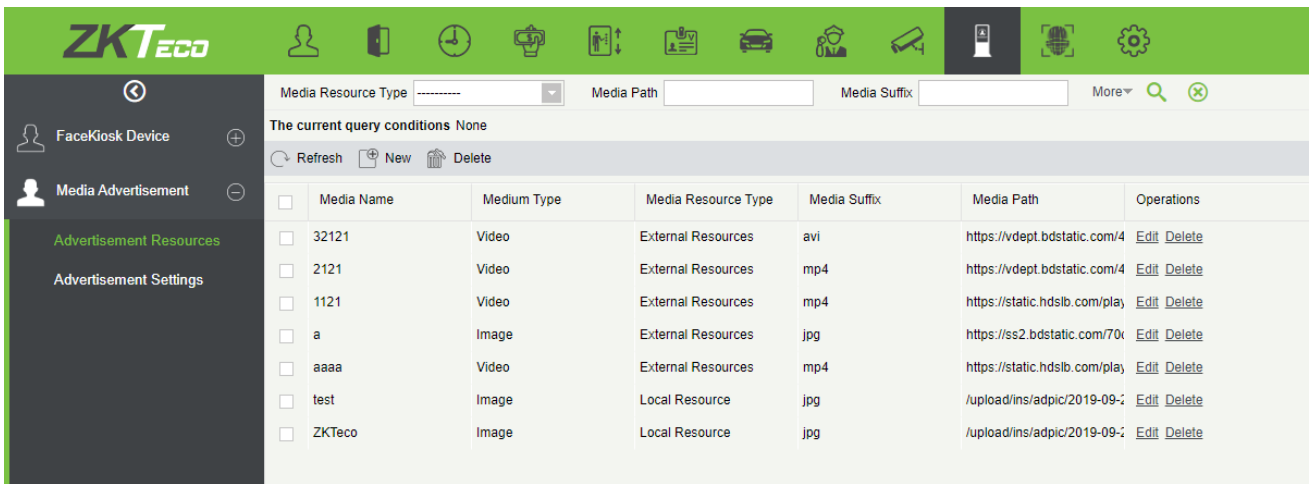

15.3.1 Add Advertising Pictures and Videos

Click **FaceKiosk** → **Media Advertisement** → **Advertisement Resources** → **New**.

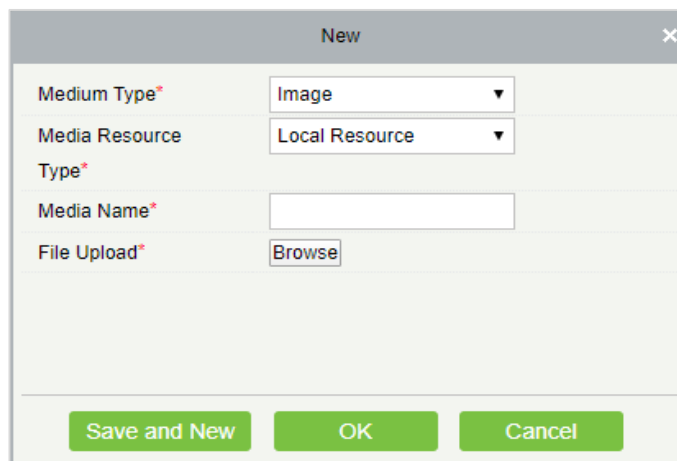

Media Type: Select the Media type. It can be an image or a video.

Media Resource Type: The media can be selected from the local PC or can be linked to an external website.

Name: Enter the image/Video name of the advertisement. It can support up to 10 characters.

File Upload: Click **Browse** and select the desired image file/video file to upload. The size and suffix name will be displayed automatically.

Note: If the file size of the advertisement video is more than 50MB, then it needs to be uploaded by USB disk. The supported video formats are MP4, WMV and AVI format, and the size must be less than 50 MB. The supported image formats are JPG, BMP, GIF, and PNG.

15.3.2 Advertisement Settings

Click **FaceKiosk** → **Media Advertisement** → **Advertisement Settings**.

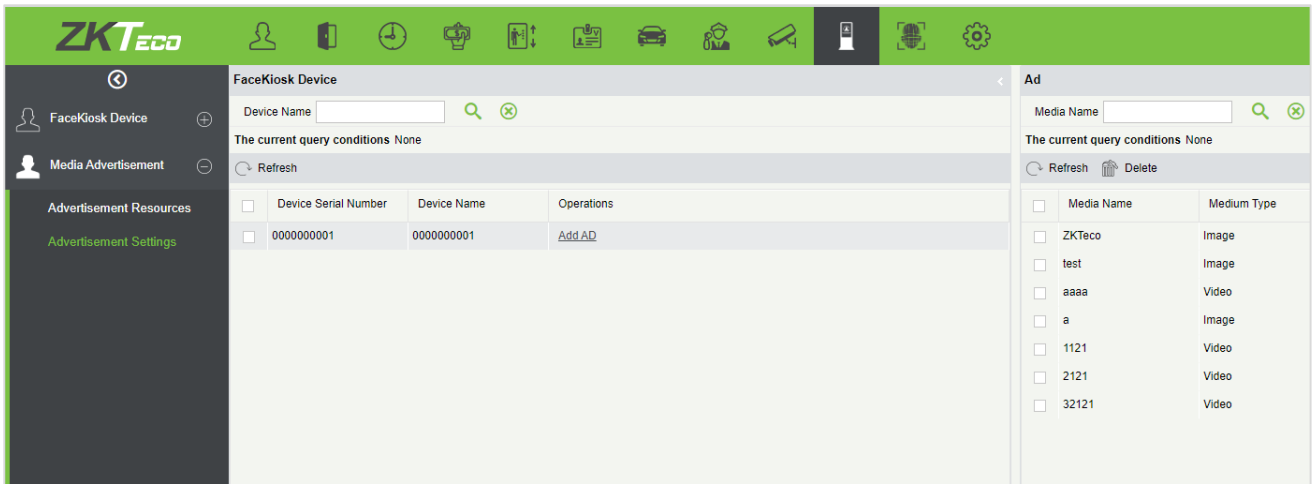

Add Advertisement

Click **Add Advertisement** to set the advertisement for the device.

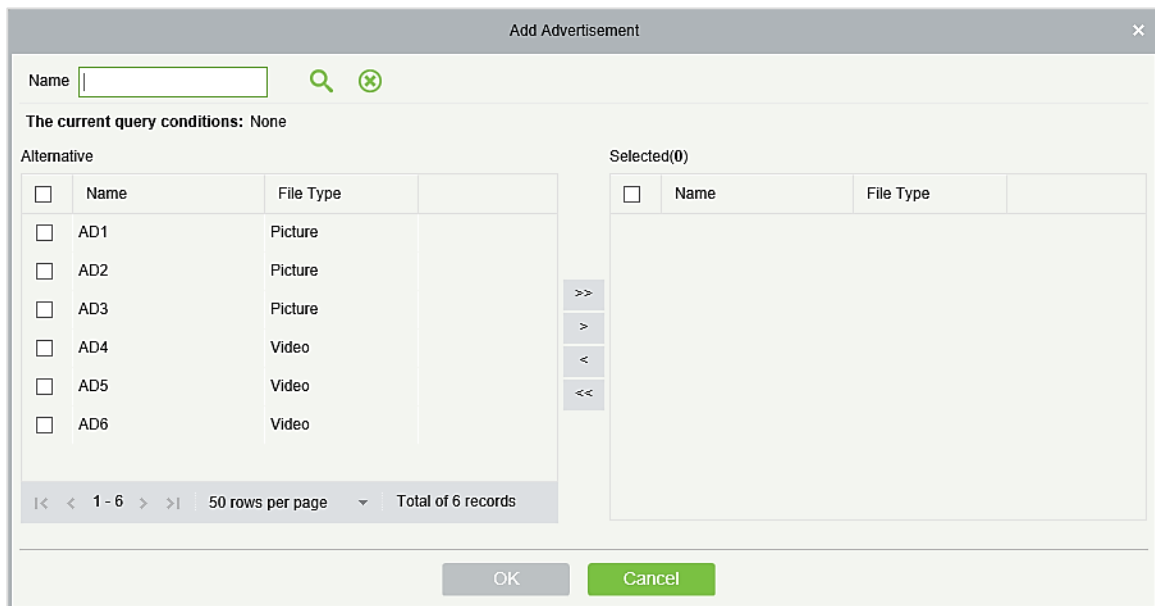

Delete advertisement

Select the required advertisement and click **Delete** to remove the advertisement content.

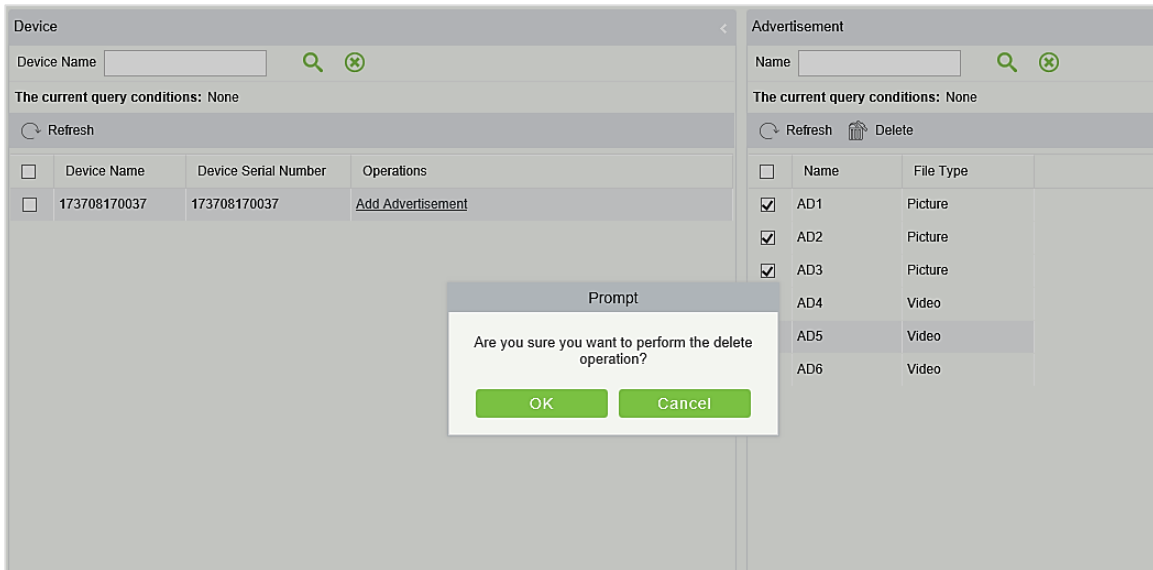

15.4 Attendance Management

Once the attendance records are uploaded to the software, you can process the attendance statistics for further operation such as Payroll calculation. Also, refer to the User Manual of ZKBioSecurity for software related queries.

15.5 Scan Code Registration

1. Go to the home screen of the device. Open the QR code scanner on your mobile phone and then scan the QR code displayed on the home screen. The registration interface will be displayed on your mobile. Enter the required details and upload your photo. You can also capture the photo from your mobile. After capturing a photo, click Register to complete the registration. For further details, refer [QR code setting](#).
2. Select **Personnel** → **Personnel** → **Temporary Personnel** to view the newly registered user.

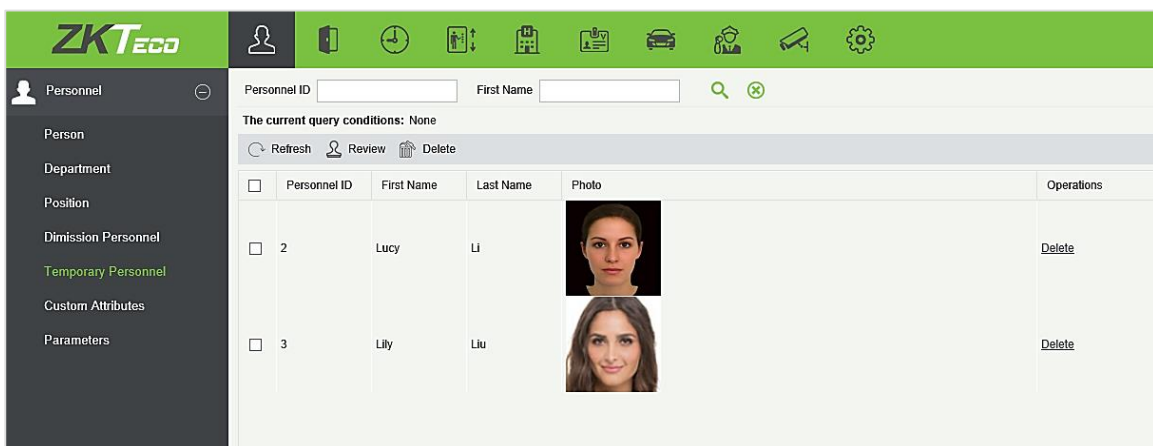

Select the desired Personnel and the Administrator. Click **Audit** to check and verify the identity of the new users. After successful approval, user verification can be carried out on the device.

ZKTeco Biometrics India Pvt. Ltd. Global R&D Centre

Survey No 01/01, Outer Ring Road, Mahadevpura,

Bengaluru, Karnataka – 560048

Phone: 080-68281342/48 | Email: sales@zkteco.in | Website: www.zkteco.in

